

Working Instructions Translation

Heating element butt welding machine

WIDOS 4900

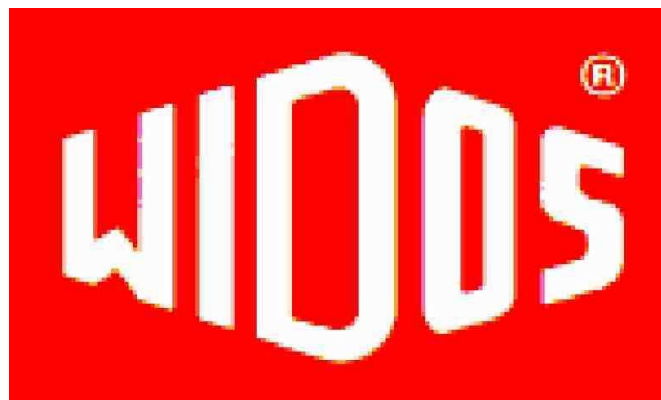

Keep for further use!

Version:	Ditch machine
Type:	WIDOS 4900
Serial number / year of construction:	see type lable

Customer's entries

Inventory- No.:	
Place of working:	

Address of manufacturer

WIDOS

W. Dommer Söhne GmbH
Einsteinstraße 5
D-71254 Ditzingen-Heimerdingen
Phone: +49 (0) 71 52 / 99 39 – 0
Fax: +49 (0) 71 52 / 99 39 – 40

Order of spare parts and sales service:

Directly at the manufacturer or at the subsidiary companies:

WIDOS GmbH
An der Wiesenmühle 15
D-09224 Grüna / Sachsen
Phone: +49 (0) 3 71 / 8 15 73 - 0
Fax: +49 (0) 3 71 / 8 15 73 - 20

WIDOS

W. Dommer AG
St. Gallerstr. 93
CH-9201 Gossau
Phone: +41 (0) 71 / 388 89 79
Fax: +41 (0) 71 / 388 89 73

Purpose of the document

These working instructions give you information about all important questions which refer to the construction and the safe working of your machine.

Just as we are, you are obliged to engage in these working instructions, as well.

Not only to run your machine economically but also to avoid damages and injuries.

Should questions arise, contact our advisers in the factory or in our subsidiary companies.

We will help you with pleasure.

According to our interest to continuously improve our products and working instructions, we kindly ask you to inform us about problems and defects which occur in exercise.

Thank you.

Structure of the working instructions

This manual is arranged in chapters, which belong to the different using phases of the machine. Therefore the searched information can be easily found.



© **WIDOS** 02.11.2011
W. Dommer Söhne GmbH
Einsteinstraße 5
D-71254 Ditzingen-Heimerdingen

All rights reserved
Reprinting only allowed with permission of the corporation.
Any changes prior to technical innovations.

1. DESCRIPTION OF PRODUCT	6
1.1. Application and prescribed use	6
1.2. Machine overview	6
1.3. Safety measures	7
1.4. Conformity	7
1.5. Designation of product	7
1.5.1 Technical Data	7
1.5.1.1 WIDOS 4900 General data	7
1.5.1.2 Planer	8
1.5.1.3 Heating element	8
1.5.1.4 Hydraulic aggregate	9
1.5.1.5 Basic frame	9
1.6. Equipment and accessories:	9
2. SAFETY RULES.....	10
2.1. Explanation of the different symbols.....	10
2.2. Obligations of the owner.....	11
2.3. Obligations of the worker	11
2.4. Organizational measures.....	11
2.5. Informal security measures.....	11
2.6. Instruction of the staff	11
2.7. Dangers while handling the machine.....	12
2.8. Maintenance and inspection, repair.....	12
2.9. Dangers caused by electric energy	12
2.10. Dangers caused by the hydraulics	12
2.11. Special dangers	13
2.11.1 Danger of catching clothes by the planer.....	13
2.11.2 Danger of noise	13
2.11.3 Danger of burning at heating element, heat protective box and welding area	13
2.11.4 Danger of stumbling over hydraulic and electric wires	13
2.11.5 Danger of squeezing by clamping tool and guideways	14
2.12. Structural modifications on the machine	14
2.13. Cleaning the machine	14
2.14. Guarantee and liability	14
3. FUNCTIONAL DESCRIPTION.....	15
4. OPERATING AND INDICATING ELEMENTS	16
4.1. Elements on the hydraulic aggregate.....	16
4.2. Elements at the heating element	17
4.3. Separating device for heating element.....	17

4.4.	Elements at the planer.....	18
5.	STARTING AND OPERATING.....	19
5.1.	Starting	19
5.1.1	Replacing the reduction inserts	20
5.1.2	Using small and large reduction inserts.....	20
5.2.	Welding process	21
6.	WELDING LOGS AND TABLES	23
7.	MAINTENANCE AND REPAIR	28
7.1.	Clamping elements	28
7.2.	Planer.....	28
7.3.	Storing	28
7.4.	Used hydraulic oil.....	28
7.5.	Checking the hydraulic oil level	28
7.6.	Venting the hydraulic cylinders.....	29
8.	TRANSPORT	30
9.	ELECTRIC AND HYDRAULIK DIAGRAMS.....	31
10.	SPARE PARTS LIST	35
10.1.	Basic machine.....	35
10.2.	Planer.....	37
10.3.	Hydraulic aggregate.....	39
10.4.	Heating element	42
10.5.	Reception box	44
11.	DECLARATION OF CONFORMITY	46

1. Description of product

This chapter gives important basic information about the product and its prescribed use. All technical details of the machine are put together as a general arrangement.

1.1. Application and prescribed use

The WIDOS 4900 is made for heating element butt welding of pipes and fittings with a diameter range of $\varnothing = 90 - 315$ mm.

It is a building site machine and is designed especially for the use on site as well as in the workshop.

For this reason, the frame is kept small such that it can also be used in constrained positions (e.g. building ditches).

All use going beyond is not prescribed.

The manufacturer is not responsible for damages caused by misuse.

The risk is held only by the user.

Prescribed use also means:

taking notice of all remarks in this manual

performing of repair works.

1.2. Machine overview



1	Planer
2	Heating element
3	Protective box
4	Hydraulic aggregate
5	Basic machine with clamping tools

1.3. Safety measures

In case of wrong use, wrong operation or wrong maintenance the machine itself or products being in the surrounding can be damaged or destroyed.

Persons being in the endangered area may be injured.

Therefore these working instructions have to be thoroughly read and the corresponding safety advices must be necessary adhered to.

1.4. Conformity

The machine corresponds in its construction to the valid recommendations of the European Community as well as to the European standard specifications.

The development, manufacturing and mounting of the machine were made very carefully.

1.5. Designation of product

The product is designated by two signs at the frame.

The type-labels are fixed on the control unit and on the basic machine.

They contain the type of the machine, the serial number, and the year of construction.

1.5.1 Technical Data

1.5.1.1 WIDOS 4900 General data

Material:	PP, PE 80, PVDF, PE 100
Pipe diameter range:	outside- \varnothing = 90 – 315 mm
Transport box (l x w x h) / weight:	approx. 1230 x 980 x 670 mm / approx. 67 kg
Partition boxes for reduction inserts:	
4- partition:	appr. 680 x 410 x 310 weight: appr. 10 kg
7- partition:	appr. 1160 x 410 x 310 weight: appr. 16 kg
9- partition:	appr. 1470 x 410 x 310 weight: appr. 21 kg
Total weight (without packing):	approx. 130 kg
Protection:	16 A
Wire cross section:	1,5 mm ²
Emissions	<ul style="list-style-type: none"> - Noises exceeding 80 dB (A) may occur; during planing it is obligatory to wear ear protection! - when using the named pipe materials and when welding below 260° C no toxicant damp arises.

Environment:	<ul style="list-style-type: none"> - keep the workshop clean (especially the welding area must be clean) - If secured by an appropriate measurement that allowed conditions for welding are indicated, it is possible to work in any outside temperature condition as far as the welder is not constrained in its manual skill. <ul style="list-style-type: none"> - avoid humidity, if necessary put up a tent - avoid strong sun beams - if it is windy shut the pipe endings.
--------------	--

1.5.1.2 Planer

Motor:	monophase-alternating current-motor
Power:	1,05 kW
Voltage:	230 V ($\pm 10 \%$)
Current:	4,5 A
Frequency:	50 Hz ($\pm 10 \%$)
RPM n2 of planer	approx. 60 revs/min.
Elements:	Switch on / off with fixing device Connecting cable and plug with earthing contact
Weight:	approx. 14 kg

1.5.1.3 Heating element

Power:	2,1 kW
Voltage:	230 V ($\pm 10 \%$)
Current:	10 A ($\pm 10 \%$)
Frequency:	50 Hz
Outside-Ø:	350 mm
Surface:	Antistick-coated
Elements:	Electronic temperature control Control lamps, switch on / off Connecting cable and plug with earthing contact
Weight:	approx. 13 kg

1.5.1.4 Hydraulic aggregate

Power:	0,3 kW
Voltage:	230 V ($\pm 10 \%$)
Current:	2,7 A
Frequency:	50 Hz
Hydraulic oil tank:	approx. 1 l
Electromotor and pump:	
RPM:	1380 (revs/min.)
max. pressure of pump:	approx. 120 bar
Working pressure:	100 bar
Volume velocity:	1,9 l/min
Weight :	approx. 23 kg

1.5.1.5 Basic frame

Dimensions (l x w x h):	800 x 460 x 500 mm
Reduction insert :	Dimensions can be selected
Material frame:	Machine steel
Material reduction inserts:	Aluminium
Weight:	approx. 60 kg
Cylinder- \varnothing :	40 mm
Piston rod- \varnothing :	35 mm
Length of stroke of cylinder:	175 mm
max. force: (F=P*A)	5900 N (at 100 bar)
Velocity of piston rod:	5,4 cm/s

Stock numbers for component parts see spare parts list

1.6. Equipment and accessories:

The following accessories are part of the first delivery:

1	Tool bag for 10 parts
1	Socket wrench size 27
1 each	Allan key size 3; 6; 7; 8
1 each	Allan key with T-grip size 5; 7
optional	Reduction inserts, roller brackets for the pipes
1	Torx-screw driver T10

2. Safety rules

The base for the safe handling and the fault-free operation of this machine is the knowledge of the basic safety indications and rules.

The security notices of this chapter represent the general part.

Particular information is listed directly before the corresponding actions.

These working instructions provide you with the most important information to run the machine safely.

The safety information must be read by all persons who work on the machine.

2.1. Explanation of the different symbols

The working instructions contain the following signs for certain situations:



This symbol means a possibly danger for the life and the health of persons.

- The disrespect of these indications may have heavy consequences for the health.



This symbol means a possible dangerous situation.

- The disrespect of these indications may cause slight injuries or damages on goods.



This symbol means a possible dangerous situation due to hot surfaces.

- The disrespect of these indications may conduct to heavy burns, respectively to self-ignition or even fire.



This symbol means a possible dangerous situation by moving parts of the machine
The disrespect of these indications may cause heavy crushings of parts of the body resp. damages of parts of the machine.



This symbol means a possible risk of injury by noises exceeding 80 dB (A).

- Ear protection is obligatory



This symbol gives important indications for the proper use of the machine.

- The disrespect of these indications may conduct to malfunctions and damages on the machine or on goods in the surrounding.



Under this symbol you get user tips and particularly useful information.

- It is a help for using all the functions on your machine in an optimal way and helps you to make the job easier.

The regulations for the prevention of accidents are valid (UVV).

2.2. Obligations of the owner

The owner is obliged only to let persons work on the machine, who

- know about basic safety and accident prevention rules and are instructed in the handling of the machine.
- The workers also must have read and understood the safety chapter of this manual and certify this with their signature.

The safety-conscious working of the staff should be checked in regular intervals.

2.3. Obligations of the worker

All persons who are to work at the machine are obliged before working:

- To take care of the basic safety and accident protection rules.
- To have read and understood the safety chapter and the warnings in this manual and to certify this with their signature.
- To inform themselves about the functions of the machine before using it.

2.4. Organizational measures

- All equipment required for personal safety is to be provided by the owner.
- All available safety equipment is to be inspected regularly.

2.5. Informal security measures

- The manual has to be permanently kept at the place of use of the machine. It is to be at the operator's disposal at any time and without effort.
- As a supplement to the working instructions, the generally valid and also the local regulations for the prevention of accidents and the protection of the environment are to be provided and adhered to.
- All security and danger notices on the machine have to be kept in a readable state.
- Every time the machine changes hands or is being rented to third persons, the working instructions are to be sent along with and their importance is to be emphasized.

2.6. Instruction of the staff

- Only skilled and instructed persons are allowed to work at the machine.
- The responsibilities of the staff are to be determined clearly concerning transport, mounting and dismounting, starting, adjusting and tooling, operating, maintenance and inspection, repairs.
- Workers who are to be trained are only allowed to work at the machine under control of an experienced worker.

2.7. Dangers while handling the machine

The machine WIDOS 4900 is constructed according to the actual technical standard and the acknowledged technical safety rules.

However, dangers for the operator or other persons standing nearby may occur.

Also damages to the machine itself or to other things are possible.

The machine must only be used:

- according to the prescription
- in safety technical impeccable status

Disturbances, which may affect the safety of the machine must be eliminated immediately.

2.8. Maintenance and inspection, repair



All maintenance and repair works have to be basically performed with the machine in off position.

During this the machine has to be secured against unauthorized switching on.



Prescribed maintenance and inspection works should be performed in time.

The DVS gives the advice of inspection works after 1 year.

For machines with a specially high usage percentage the testing cycle should be shortened.

The works should be performed at the WIDOS GmbH company or by an authorized partner.

2.9. Dangers caused by electric energy



Only skilled workers are allowed to work at electrical appliances!

The electrical equipment of the machine has to be checked regularly.

- Loose connections and damaged cables have to be replaced immediately.
- If works at alive parts are necessary, a second person has to assist who can disconnect the machine from the mains if necessary.
- All electric tools (heating element, planer and aggregate) have to be protected from rain and dropping water (if need be use a welding tent).
- According to VDE 0100, the use on construction sites is only allowed with a power distributor with a FI-safety switch.

2.10. Dangers caused by the hydraulics



System parts and pressure hoses should be made pressureless before beginning of any repair works. Even if the machine is switched off, pressure may be in the hydraulic accumulator!

There is a danger of injuring the eyes by hydraulic oil squirting out.

- Damaged hydraulic hoses have to be immediately replaced.
- Make a visual inspection of the hydraulic hoses before each work beginning.
- The hydraulic oil is inedible!

2.11. Special dangers

2.11.1 Danger of catching clothes by the planer



There is the danger of cutting yourself or even breaking bones!

- Wear only tight clothes.
- Do not wear rings or jewellery during work.
- If necessary wear a hair-net.
- Always put the planer back into the reception case after and before each use.
- Only transport the planer at the handle.
- Do not touch the planer surfaces.
- Switch on the planer only for use. Otherwise the planer will start every time when the security microswitch is pressed.

2.11.2 Danger of noise



Noises exceeding 80 dB (A) may occur; during planing it is obligatory to wear ear protection!

2.11.3 Danger of burning at heating element, heat protective box and welding area



You can burn yourself, inflammable materials can be ignited!
The heating element is heated up to more than **200 °C / 392 °F!**

- Do not touch the surface of the heating element.
- Do not leave the heating element unattended.
- Take enough safety distance to materials which might be ignited.
- Wear safety gloves.
- Insert the heating element into the heat protective box after use.
- Only transport the heating element at the handle.

2.11.4 Danger of stumbling over hydraulic and electric wires

- Make sure that no person has to step over the wires.
- Make sure that the cables lie in such a way that the danger is maintained at a minimum.

2.11.5 Danger of squeezing by clamping tool and guideways



There is a possibility of serious injury:
On the one hand between the inner clamping tools and on the other hand between the outside clamping tool and the end of the guideway.

- Do not put hands or foot between clamped pipe ends.
- Do not step or grab between the inner clamping tools with not yet clamped pipes.
- Do not block opening and closing of the machine.

2.12. Structural modifications on the machine

- No modifications, extensions or reconstructions may be performed on the machine without permission of the manufacturer.
- Machine parts that are not in perfect condition are to be replaced immediately.
- Only use original **WIDOS** spare and wear parts.
- In case of purchase orders please always note the machine and version number.

2.13. Cleaning the machine

- The used materials and cloths are to be handled properly and to be disposed of, especially
 - during cleaning with solvents
 - when lubricating with oil and grease

2.14. Guarantee and liability

Fundamentally our "general sales and delivery conditions" are in force.
They are at the buyer's disposal latest before making the contract.
Guarantee and liability demands referring to damages of persons or things are excluded if they are caused by one or several of the following reasons:

- Not using the machine according to the prescription.
- Unprofessional transport, building-up, starting , operating and maintenance of the machine.
- Running the machine with defective or not properly mounted safety equipment.
- Ignoring the information given in this manual.
- Structural changes on the machine without permission.
- Unsatisfactory checkings of parts of the machine, which are worn out.
- Unprofessionally performed repairs.
- In case of catastrophes and acts of God.

3. Functional description

Basically the international and national standard specifications are to be fulfilled.

The plastic pipes are clamped by means of the clamping tools.

Then the foreparts are planed parallel by means of the **planer**, and mismatch is checked.

Now the heating element is inserted and the pipes are pressed against the heating element with the defined adjusting pressure. This operation is called "**adjusting**".

After the prescribed bead height is reached, the pressure is relieved and the **heat-up time** is starting. Now the pipes are heated up to welding temperature.

After expiration of the heat-up time, the slide has to be opened, the heating element is removed quickly and the pipes are rejoined. The time between removing the heating element and rejoining the pipes is called **change-over time**.

The pipes are joined with the prescribed welding pressure and then cool down under pressure (**cooling time**).

The weld joint can be unclamped, the welding process is finished.

Heating element heats the pipes
up to welding temperature

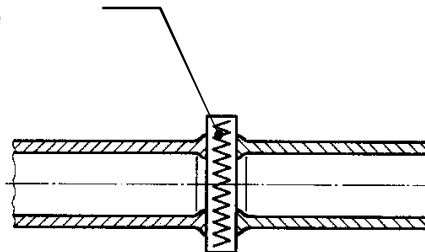

Finished weld joint with
internal and external bead

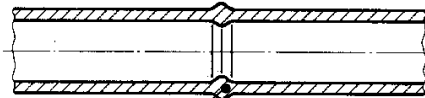

4. Operating and indicating elements

4.1. Elements on the hydraulic aggregate



No.	Denomination	Function
7	Pressure gauge	Digital display of the hydraulic pressure
8	Valve lever	Opening/closing the slide. There are 4 different positions: - to the left side : slide closes - in the middle (usual position): the pressure is currently achieved is kept (also by means of the hydraulic accumulator) - slightly to the right side (position pressureless): a possibly existing pressure is released without moving the slide. Due to the hydraulic accumulator it takes about 10 s until the pressure is completely released. - to the right side : slide opens
9	Adjusting screw for pressure relief valve	- For the limitation of the hydraulic pressure to the desired value
10	Hydraulic connection for closing	- Non-dropping quick-action hose coupling
11	Hydraulic connection for opening	- Non-dropping quick-action hose coupling
12	Screw with oil level stick	- Checking the oil-level - Filling in oil

4.2. Elements at the heating element



No.	Denomination	Function
16	Control lamp green	- There are three different states: <ul style="list-style-type: none"> • off: signals that the heating element is not heated up at the moment or that it cools down • blinking: the heating element temperature is maintained by a certain pulse-position ratio • on: signals that the heating element is heated up at the moment. It has not yet reached the desired temperature
17	Setting screw	- For regulating the temperature of the heating element
18	On/off-switch with red lamp	- As soon as the heating element is switched on, the red control lamp lightens

4.3. Separating device for heating element

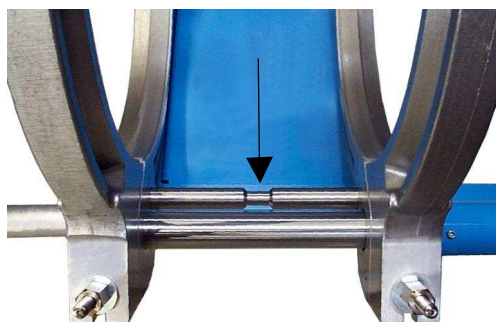

There is a tear-off bar mounted between the movable and the fixed clamping shells on the basic machine. It prevents the heating element from sticking to the heated-up pipe ends. When inserting the heating element take care that it lies in the zone of the throat of the tear-off bar (see arrow).

4.4. Elements at the planer

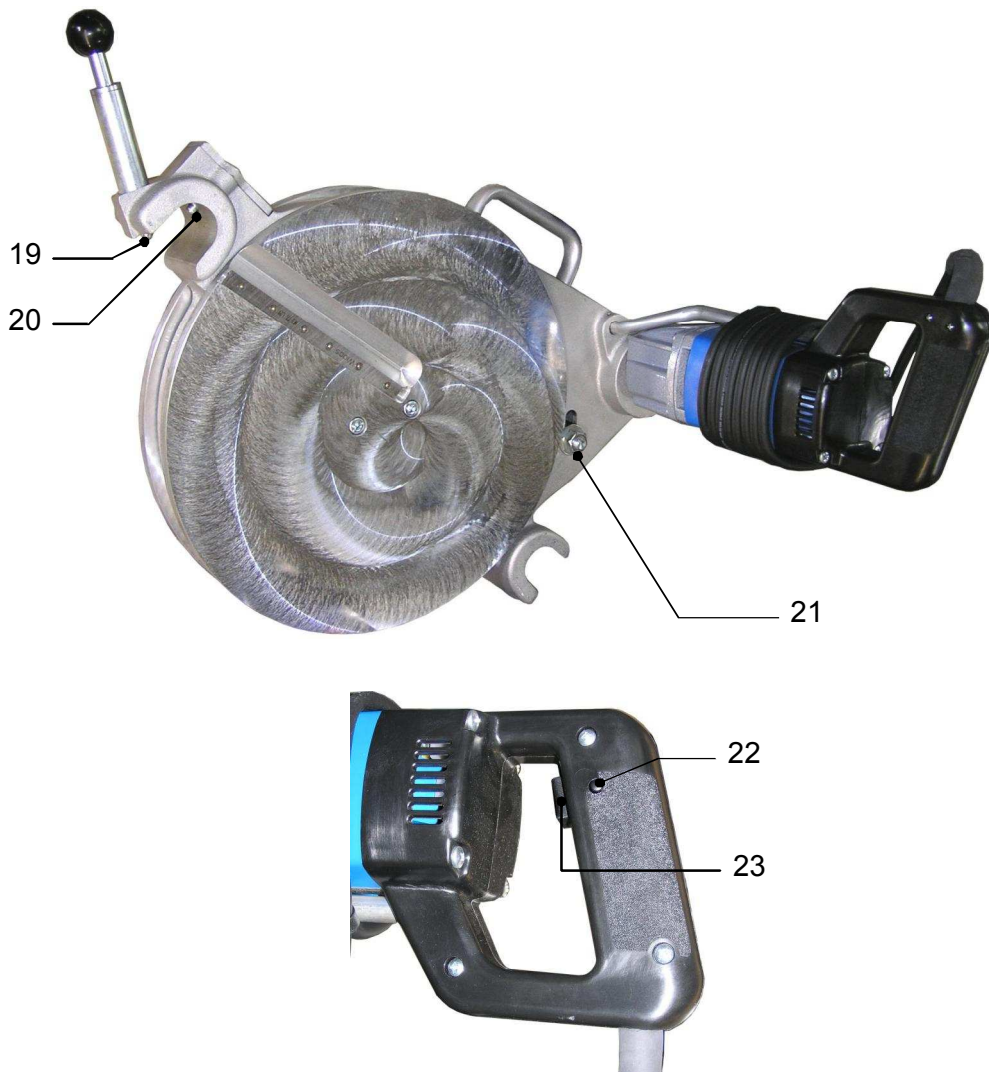

No.	Denomination	Function
19	Locking lever	- protection against unintentional running. - to lock the planer, thus avoiding a falling out.
20	Protection switch	- planer can only start when switch is pressed
21	Chain tightening bolt	- in order to tighten the chain, disassemble the cap at the rear of the planer, then tighten the chain sturdily
22	Locking button	- if the switch is activated you may press the locking button, thus the activation is maintained as long as the switch is deactivated.
23	Switch on / off for planer	- to switch on the planer. - the planer has to be switched off before and after use.

5. Starting and operating

The instructions of this chapter are supposed to instruct you in the operation of the machine and to lead you during the appropriate starting of the machine.

This includes:

- the safe operation of the machine
- using all the possibilities
- running the machine economically

5.1. Starting



The machine should only be operated by trained and authorized people.

For the qualification a plastic welding exam can be taken according to DVS and DVGW.

In case of danger unplug the machine immediately.

In case of power failure, the hydraulic system can still be under pressure.

For this reason, release pressure when required.

After completion of the welding work and during breaks the machine has to be switched off. Further be sure that no unauthorized persons have access.

Protect the machine from wetness and moisture!

Operating the machine on construction sites is only allowed with an in-coming power distributor with a FI safety switch according to VDE 0100.



Check the oil level of the hydraulic system before each starting in order to avoid damages on the pump.

The oil-level must be between the two markers.

Connect the power line plug of the hydraulic aggregate to the mains, and be sure to have a correct mains voltage (230 V / 50 Hz).

Connect the heating element and planer to the corresponding plug box of the aggregate.

Connect the hydraulic hoses of the basic machine to the aggregate.



Lay hydraulic and electric lines carefully (danger of stumbling) !

Take into consideration the environmental conditions:

- Welding should not be carried out in direct sunlight.
- If necessary put up a welding tent.
- In case of ambient temperatures below 5°C the following measures have to be taken: If need be, put up a welding tent and heat up the pipe ends.
- Take measures against rain, wind and dust.

5.1.1 Replacing the reduction inserts

- Unscrew the already mounted reduction inserts.
- Screw on the reduction inserts with the corresponding diameter.
- If necessary (e.g. T-pieces), the fixed outside clamping tool can be dismantled by unscrewing the three allen screws.

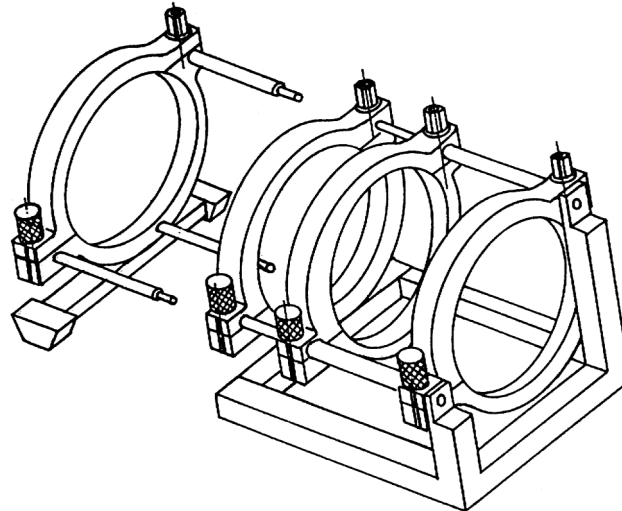

Dismantling of the fixed outside clamping tool

5.1.2 Using small and large reduction inserts

Small reduction inserts:

- Pipe fittings often only have a short straight surface area on which they can be clamped.
- Fittings often need to be clamped in the inside clamping tools with the narrow reduction inserts.
- In case of welding fittings (elbows, T-pieces etc.) the inside narrow reduction insert can also be used flush with the outside.

The picture shows both internal clamping tools.

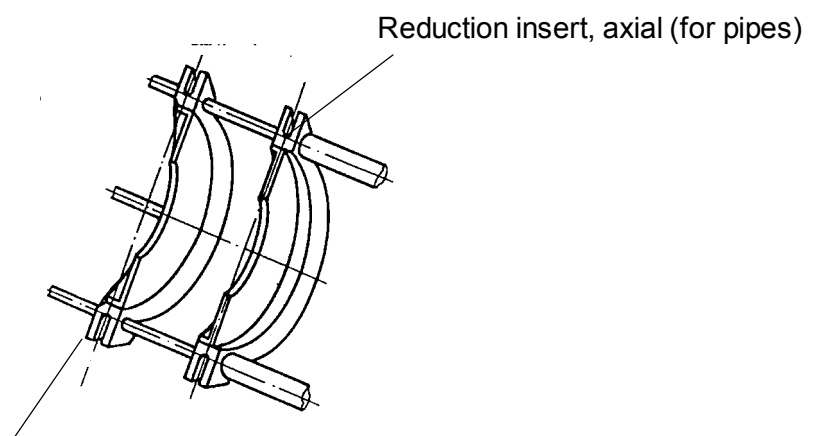

Reduction insert narrow, flush with the outside (for elbows, T-pieces)

Large reduction inserts:

They are mainly used for a good tightening and are generally mounted on the inside clamping tools.

Super large reduction inserts have a specially high guidance quality and are mainly used during the welding of fittings with long legs which can only be clamped with a single clamping tool.

5.2. Welding process

The respectively valid welding prescriptions (ISO / CEN / DVS...) are to be basically followed.



There is the danger of serious bruising.

On the one hand between the inner clamping tools, on the other hand between the outer clamping tool and the end of the guide bar.

- Do wear safety gloves as a protection against burning !
- A stop-watch should be available for recording the actual times for the heating and cooling.
- In the same way a table should be available from which the parameters for the pipe dimensions to be welded prescribed by the welding prescriptions may be taken from.
- The heating element surfaces are to be clean and, above all, free from grease. Therefore they are to be cleaned with non-fraying paper and detergent (e.g. PE - cleaner) before every welding or if they are dirty. The anti-adhesive coating of the heating element has to remain undamaged in the working area.
- Switch on the heating element and adjust the required welding temperature at the adjusting screw.
 - The adjusted temperature is obtained when the control light is blinking.
- Screw in the reduction inserts according to the outside diameter of the pipes to be welded.
- Put the workpieces into the clamping tools, tighten the clamping nuts tightly and align the workpieces with respect to one another.

In case of long pipe ends, use WIDOS rollerstands for alignment.

- Close the slide, thereby reading the **movement pressure** on the manometer. The movement pressure is displayed exactly when the slide with the clamped-pipe passes over into its movement.
- Subsequently, open slide again such that the planer fits therebetween.
- Put the planer between the pipe ends, allow handle to lock with the security micro switch and switch on. Switch on the on/off--switch (chapter: 4.4, no. 22) and press the locking button (23) as needed



There is the danger that the planer pulls in clothes !

In case planer is switched on it will run immediately when the security microswitch has been pressed.

Do not hold the planer on its front sides in any case.

- Move the pipe ends towards one another by means of the valve lever and plane same with a planing pressure between 1 and 15 bar above the movement pressure.
Planing must be carried out until a revolving cutting has been formed on both sides.
- Open the slide again by means of the valve lever, switch off planer motor, remove planer and put it into the heat protective box.
- Remove the produced cuttings without contacting the worked surfaces.
- Close slide.
- Check pipe mismatch and gap on the joining pipe ends. According to DVS 2207, the mismatch on the pipe outer side must not exceed $0.1 \times$ pipe wall thickness, the admissible gap must not exceed 0.5 mm.
The mismatch compensation is carried out via further tightening or releasing of the clamping nuts.
In case of a mismatch compensation, planing must be carried out again afterwards.
- The adjustment pressure for the pipe dimension to be welded can be gathered from the table. Add the movement pressure.
Set the resulting pressure value at the pressure limiter valve and check by actuating the valve lever.
- Open slide again slightly.
- Take heating up time, maximum change-over time, cooling down time and bead height for the pipe dimension to be welded from the table.
- Move the heating element, which has been cleaned and brought to nominal temperature, by means of the handle upwards between the pipes, if necessary wait until the control lamp on the heating element flashes in regular intervals.
Take care that it lies in the zone of the throat of the tear-off bar (see point 4.3).
- Close slide smoothly to the set adjustment pressure.
When the prescribed revolving bead height has been reached, reduce pressure. For this purpose, move the valve lever to the position „pressure-less“ until the desired heating up pressure has built up (heating up pressure = approx. 10% of the adjustment pressure).
- The heating up time starts now. Press the stop watch and compare the actual time with the nominal time taken from the table.
- After expiration of the heating up time, open the slide, remove the heating element as quickly as possible, put it into the heat protective box and close the slide smoothly.
The maximum time frame for this process is predetermined by the value for the change-over time taken from the table.
- When the welding pressure has been built up, press the stop-watch and keep the control lever for approximately 10s on the position „pressure“ so that the hydraulic accumulator can be filled. During the cooling down period re-adjust pressure, if necessary (the pressure for cooling down is the same as the set adjustment pressure).
- After expiration of the cooling down period, release pressure, remove the welded parts and open the slide.

6. Welding logs and tables

Table for PE

Foundation: 2207, 2208 DIN 16932 German association for welding

Use for: **4900**

1 bar on manometer: **59 N**

PE 80 The value for heating element temperature is between 200° C - 220° C.
The **smaller** the pipe wall the **higher** the temperature.

PE 100 The standard value for heating element temperature is 220° C.
Increase the change-over time and the welding pressure time at PE 100 as fast as possible !

Additional to the given bead-up force and to the welding force the moving force of the support must be added !

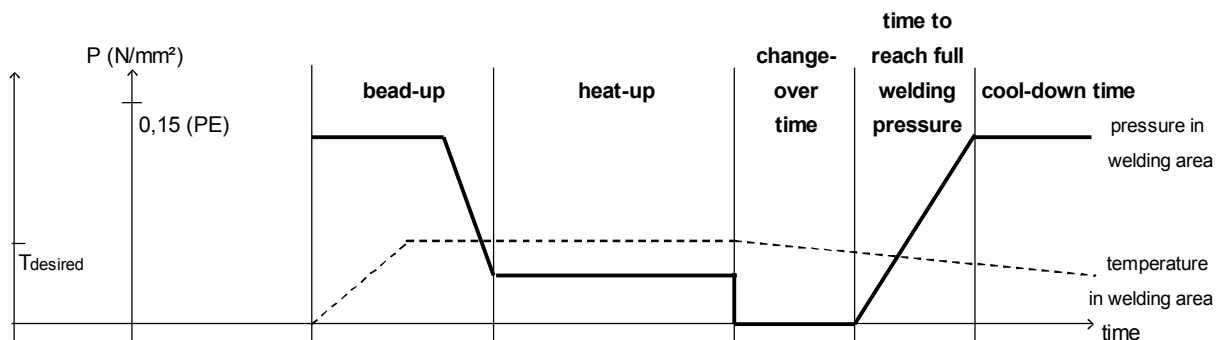

pipe diameter OD [mm]	pipe wall (s) [mm]	SDR	bead-up pressure [bar]	circular bead min. [mm]	heat-up time [s]	max. change-over time [s]	time to reach welding pressure [s]	welding pressure [bar]	cool-down time [min] 1
90	2,2	41,0	2	0,5	22	4	4	2	2
	2,8	33,0	2	0,5	28	4	4	2	3
	3,5	26,0	3	0,5	35	5	5	3	4
	4,3	21,0	3	0,5	43	5	5	3	6
	5,1	17,6	4	1,0	51	5	5	4	7
	5,4	17,0	4	1,0	54	5	5	4	7
	6,7	13,6	5	1,0	67	6	6	5	10
	8,2	11,0	6	1,5	82	6	6	6	11
	10,1	9,0	7	1,5	101	7	7	7	14
12,3	7,4	8	2,0	123	8	8	8	16	
110	2,7	41,0	3	0,5	27	4	4	3	3
	3,4	33,0	3	0,5	34	5	5	3	4
	4,2	26,0	4	0,5	42	5	5	4	6
	5,3	21,0	5	1,0	53	5	5	5	7
	6,3	17,6	6	1,0	63	6	6	6	9
	6,6	17,0	6	1,0	66	6	6	6	9
	8,1	13,6	7	1,5	81	6	6	7	11
	10,0	11,0	8	1,5	100	7	7	8	14
	12,3	9,0	10	2,0	123	8	8	10	16
15,1	7,4	12	2,0	151	9	9	12	20	

Table for PE

Foundation: 2207, 2208 DIN 16932 German association for welding

Use for: **4900**

1 bar on manometer: **59 N**

PE 80 The value for heating element temperature is between 200° C - 220° C.
The **smaller** the pipe wall the **higher** the temperature.

PE 100 The standard value for heating element temperature is 220° C.
Increase the change-over time and the welding pressure time at PE 100 as fast as possible !

Additional to the given bead-up force and to the welding force the moving force of the support must be added !

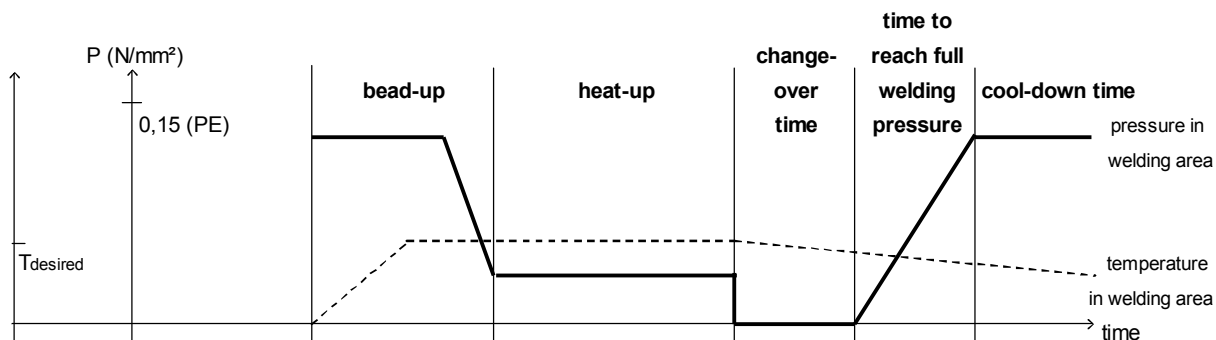

pipe diameter OD [mm]	pipe wall (s) [mm]	SDR	bead-up pressure [bar]	circular bead min. [mm]	heat-up time [s]	max. change-over time [s]	time to reach welding pressure [s]	welding pressure [bar]	cool-down time [min] ①
125	3,1	41,0	4	0,5	31	4	4	4	4
	3,9	33,0	4	0,5	39	5	5	4	5
	4,8	26,0	5	1,0	48	5	5	5	6
	6,0	21,0	6	1,0	60	6	6	6	8
	7,1	17,6	7	1,5	71	6	6	7	10
	7,4	17,0	7	1,5	74	6	6	7	10
	9,2	13,6	9	1,5	92	7	7	9	13
	11,4	11,0	11	1,5	114	8	8	11	15
	14,0	9,0	13	2,0	140	9	9	13	18
17,1	7,4	15	2,0	171	9	10	15	22	
140	3,5	41,0	4	0,5	35	5	5	4	4
	4,3	33,0	5	0,5	43	5	5	5	6
	5,4	26,0	6	1,0	54	5	5	6	7
	6,7	21,0	8	1,0	67	6	6	8	10
	8,0	17,6	9	1,5	80	6	6	9	11
	8,3	17,0	9	1,5	83	7	7	9	12
	10,3	13,6	11	1,5	103	7	7	11	14
	12,7	11,0	13	2,0	127	8	8	13	17
	15,7	9,0	16	2,0	157	9	10	16	20
19,2	7,4	19	2,5	192	10	11	19	24	
160	4,0	41,0	5	0,5	40	5	5	5	5
	4,9	33,0	7	1,0	49	5	5	7	7
	6,2	26,0	8	1,0	62	6	6	8	9
	7,7	21,0	10	1,5	77	6	6	10	11
	9,1	17,6	11	1,5	91	7	7	11	13
	9,5	17,0	12	1,5	95	7	7	12	13
	11,8	13,6	14	1,5	118	8	8	14	16
	14,6	11,0	17	2,0	146	9	9	17	19
	17,9	9,0	21	2,0	179	10	11	21	23
21,9	7,4	25	2,5	219	11	12	25	27	

Table for PE

Foundation: 2207, 2208 DIN 16932 German association for welding

Use for: **4900**

1 bar on manometer: **59 N**

PE 80 The value for heating element temperature is between 200° C - 220° C.
The **smaller** the pipe wall the **higher** the temperature.

PE 100 The standard value for heating element temperature is 220° C.
Increase the change-over time and the welding pressure time at PE 100 as fast as possible !

Additional to the given bead-up force and to the welding force the moving force of the support must be added !

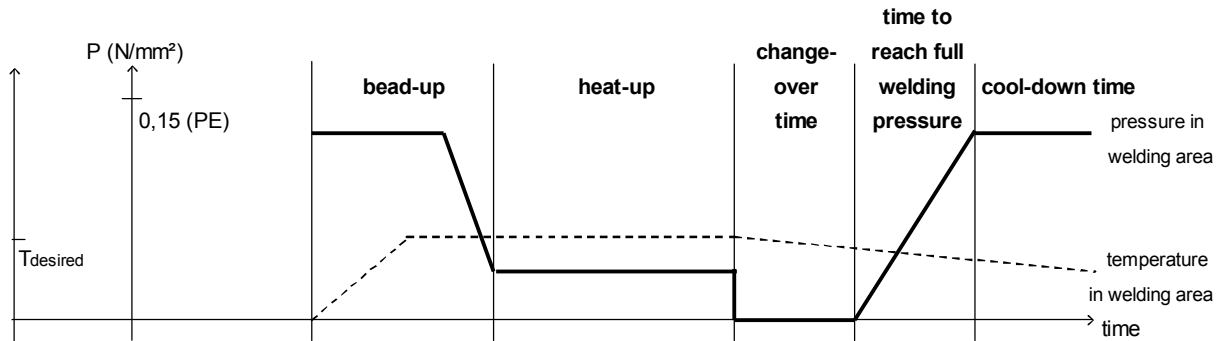

pipe diameter OD [mm]	pipe wall (s) [mm]	SDR	bead-up pressure [bar]	circular bead min. [mm]	heat-up time [s]	max. change-over time [s]	time to reach welding pressure [s]	welding pressure [bar]	cool-down time [min] ①
180	4,4	41,0	7	0,5	44	5	5	7	6
	5,5	33,0	8	1,0	55	5	5	8	8
	6,9	26,0	10	1,0	69	6	6	10	10
	8,6	21,0	12	1,5	86	7	7	12	12
	10,2	17,6	14	1,5	102	7	7	14	14
	10,7	17,0	15	1,5	107	7	7	15	14
	13,3	13,6	18	2,0	133	8	9	18	17
	16,4	11,0	22	2,0	164	9	10	22	21
	20,1	9,0	26	2,5	201	10	11	26	25
24,6	7,4	31	2,5	246	12	13	31	30	
200	4,9	41,0	8	1,0	49	5	5	8	7
	6,2	33,0	10	1,0	62	6	6	10	9
	7,7	26,0	12	1,5	77	6	6	12	11
	9,6	21,0	15	1,5	96	7	7	15	13
	11,4	17,6	18	1,5	114	8	8	18	15
	11,9	17,0	18	1,5	119	8	8	18	16
	14,7	13,6	22	2,0	147	9	9	22	19
	18,2	11,0	27	2,0	182	10	11	27	23
	22,4	9,0	32	2,5	224	11	12	32	28
27,4	7,4	38	3,0	274	13	15	38	34	
225	5,5	41,0	10	1,0	55	5	5	10	8
	6,9	33,0	13	1,0	69	6	6	13	10
	8,6	26,0	15	1,5	86	7	7	15	12
	10,8	21,0	19	1,5	108	8	8	19	15
	12,8	17,6	22	2,0	128	8	8	22	17
	13,4	17,0	23	2,0	134	8	9	23	18
	16,6	13,6	28	2,0	166	9	10	28	21
	20,5	11,0	34	2,5	205	10	12	34	26
	25,2	9,0	41	2,5	252	12	14	41	31
30,8	7,4	48	3,0	308	14	16	48	38	

Table for PE

Foundation: 2207, 2208 DIN 16932 German association for welding

Use for: **4900**

1 bar on manometer: **59 N**

PE 80 The value for heating element temperature is between 200° C - 220° C.
The **smaller** the pipe wall the **higher** the temperature.

PE 100 The standard value for heating element temperature is 220° C.
Increase the change-over time and the welding pressure time at PE 100 as fast as possible !

Additional to the given bead-up force and to the welding force the moving force of the support must be added !

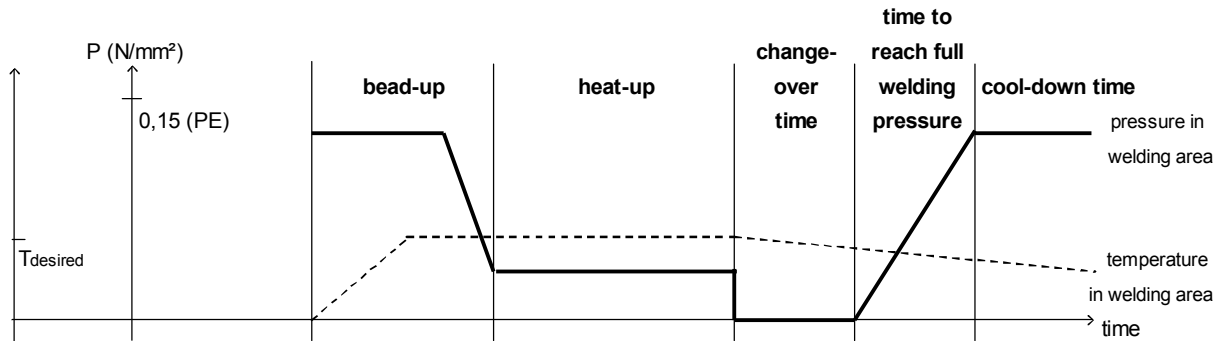

pipe diameter OD [mm]	pipe wall (s) [mm]	SDR	bead-up pressure [bar]	circular bead min. [mm]	heat-up time [s]	max. change-over time [s]	time to reach welding pressure [s]	welding pressure [bar]	cool-down time [min] ①
250	6,2	41,0	13	1,0	62	6	6	13	9
	7,7	33,0	15	1,5	77	6	6	15	11
	9,6	26,0	19	1,5	96	7	7	19	13
	11,9	21,0	23	1,5	119	8	8	23	16
	14,2	17,6	27	2,0	142	9	9	27	19
	14,8	17,0	28	2,0	148	9	9	28	19
	18,4	13,6	35	2,0	184	10	11	35	23
	22,7	11,0	42	2,5	227	11	13	42	28
	27,9	9,0	50	3,0	279	13	15	50	34
34,2	7,4	59	3,0	342	15	18	59	42	
280	6,9	41,0	16	1,0	69	6	6	16	10
	8,6	33,0	19	1,5	86	7	7	19	12
	10,7	26,0	24	1,5	107	7	7	24	14
	13,4	21,0	29	2,0	134	8	9	29	18
	15,9	17,6	34	2,0	159	9	10	34	20
	16,6	17,0	35	2,0	166	9	10	35	21
	20,6	13,6	43	2,5	206	10	12	43	26
	25,4	11,0	52	2,5	254	12	14	52	31
	31,3	9,0	63	3,0	313	14	16	63	38
38,3	7,4	74	3,5	383	16	20	74	47	

Table for PE

Foundation: 2207, 2208 DIN 16932 German association for welding

Use for: **4900**

1 bar on manometer: **59 N**

PE 80 The value for heating element temperature is between 200° C - 220° C.
The **smaller** the pipe wall the **higher** the temperature.

PE 100 The standard value for heating element temperature is 220° C.
Increase the change-over time and the welding pressure time at PE 100 as fast as possible !

Additional to the given bead-up force and to the welding force the moving force of the support must be added !

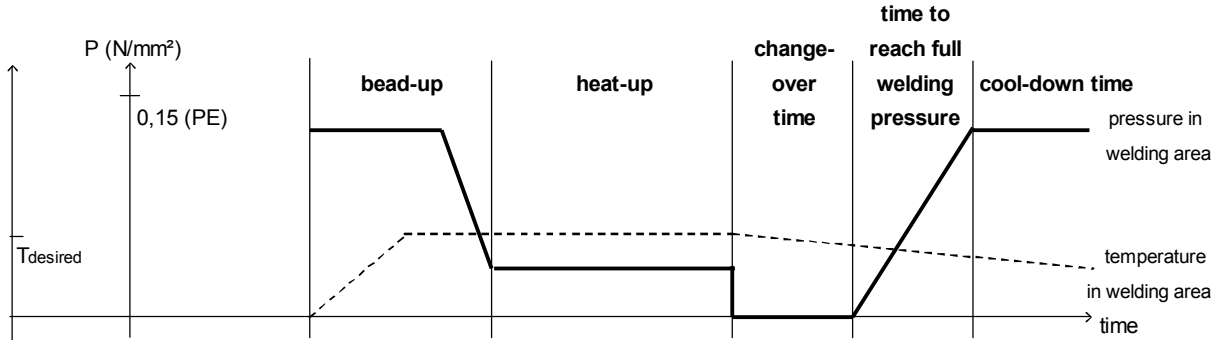

pipe diameter OD [mm]	pipe wall (s) [mm]	SDR	bead-up pressure [bar]	circular bead min. [mm]	heat-up time [s]	max. change-over time [s]	time to reach welding pressure [s]	welding pressure [bar]	cool-down time [min] ^①
315	7,7	41,0	19	1,5	77	6	6	19	11
	9,7	33,0	24	1,5	97	7	7	24	13
	12,1	26,0	30	2,0	121	8	8	30	16
	15,0	21,0	36	2,0	150	9	9	36	19
	17,9	17,6	43	2,0	179	10	11	43	23
	18,7	17,0	45	2,0	187	10	11	45	24
	23,2	13,6	55	2,5	232	11	13	55	29
	28,6	11,0	66	3,0	286	13	15	66	35
	35,2	9,0	79	3,0	352	15	18	79	43
43,1	7,4	94	3,5	431	18	22	94	52	

① Remaining under the cool-down time for up to 50% is allowed under the following conditions:

- prefabrication under workshop conditions
- low additional pressure at unclamping
- no additional pressure during further cooling down
- load onto the workpieces only after being completely cooled down

Table for PP

Foundation: 2207, 2208 DIN 16932 German association for welding

Use for: **4900**

1 bar on manometer: **59 N**

The standard value for heating element temperature is 210° C +/- 10° C.

The **smaller** the pipe wall the **higher** the temperature.

Additional to the given bead-up force and to the welding force the moving force of the support must be added !

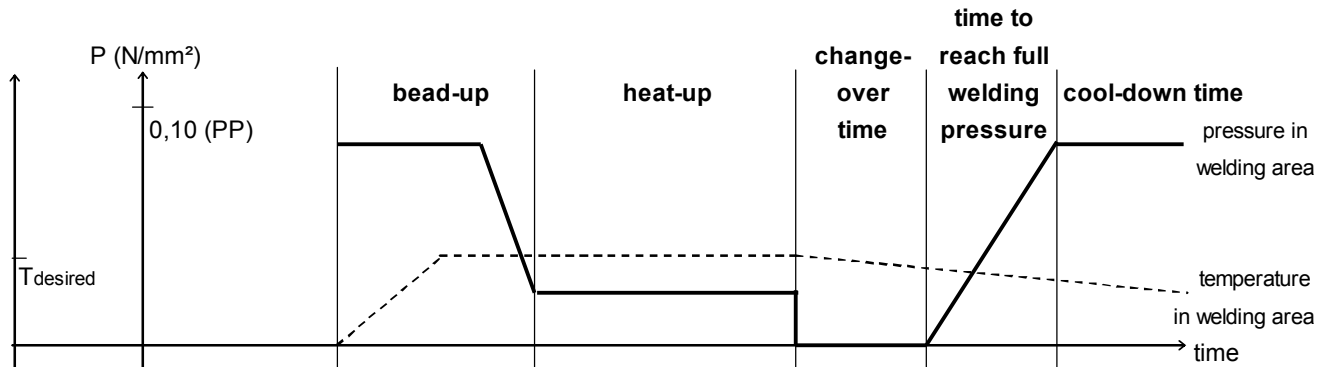

pipe diameter OD [mm]	pipe wall (s) [mm]	SDR	bead-up pressure [bar]	circular bead min. [mm]	heat-up time [s]	max. change-over time [s]	time to reach welding pressure [s]	welding pressure [bar]	cool-down time [min]
90	2,2	41	2	0,5	94	4	5	2	2
	2,8	33	2	0,5	104	4	5	2	3
	3,5	26	2	0,5	117	5	6	2	4
	5,1	17,6	3	0,5	145	5	6	3	7
	8,2	11	4	1,0	192	6	8	4	14
	12,3	7,4	6	1,0	249	7	11	6	20
	15,0	6	6	1,0	281	8	14	6	24
110	2,7	41	2	0,5	103	4	5	2	3
	3,4	33	2	0,5	115	5	6	2	4
	4,2	26	3	0,5	130	5	6	3	6
	6,3	17,6	4	0,5	164	6	7	4	10
	10,0	11	6	1,0	217	7	9	6	17
	15,1	7,4	8	1,0	283	8	14	8	24
	18,3	6	9	1,0	322	9	16	9	29
125	3,1	41	3	0,5	110	4	5	3	4
	3,9	33	3	0,5	124	5	6	3	5
	4,8	26	4	0,5	140	5	6	4	7
	7,1	17,6	5	1,0	176	6	7	5	12
	11,4	11	7	1,0	237	7	11	7	19
	17,1	7,4	10	1,0	307	8	15	10	27
	20,8	6	12	1,5	348	10	18	12	33

Table for PP

Foundation: 2207, 2208 DIN 16932 German association for welding

Use for: **4900**

1 bar on manometer: **59 N**

The standard value for heating element temperature is 210° C +/- 10° C.

The **smaller** the pipe wall the **higher** the temperature.

Additional to the given bead-up force and to the welding force the moving force of the support must be added !

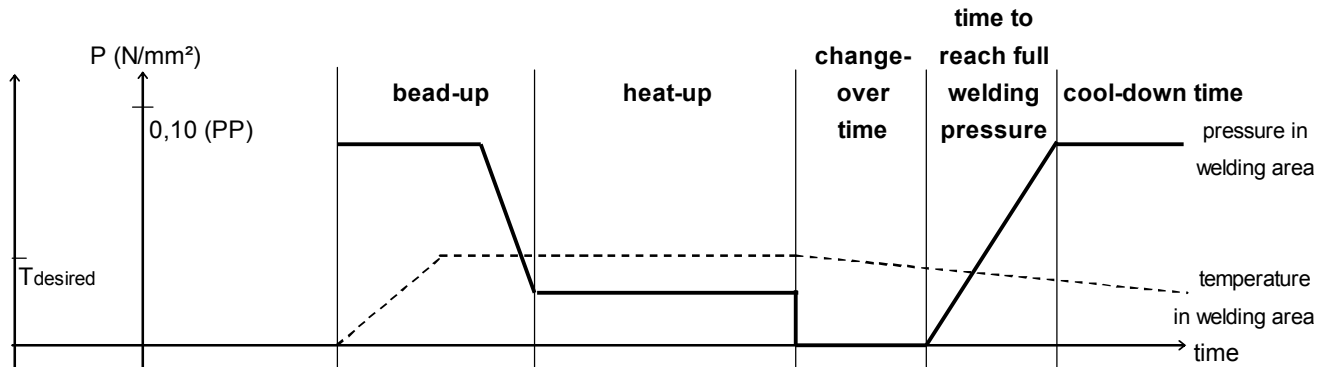

pipe diameter OD [mm]	pipe wall (s) [mm]	SDR	bead-up pressure [bar]	circular bead min. [mm]	heat-up time [s]	max. change-over time [s]	time to reach welding pressure [s]	welding pressure [bar]	cool-down time [min]
140	3,5	41	3	0,5	117	5	6	3	4
	4,3	33	4	0,5	131	5	6	4	6
	5,4	26	4	0,5	149	5	6	4	8
	8,0	17,6	6	1,0	189	6	8	6	14
	12,7	11	9	1,0	254	7	12	9	21
	19,2	7,4	13	1,5	332	9	17	13	30
	23,3	6	15	1,5	373	10	20	15	36
160	4,0	41	4	0,5	126	5	6	4	5
	4,9	33	5	0,5	141	5	6	5	7
	6,2	26	6	0,5	162	6	7	6	10
	9,1	17,6	8	1,0	204	6	9	8	15
	14,6	11	12	1,0	277	8	13	12	24
	21,9	7,4	17	1,5	359	10	19	17	34
	26,6	6	19	2,0	405	11	23	19	41
180	4,4	41	5	0,5	133	5	6	5	6
	5,5	33	6	0,5	151	5	6	6	8
	6,9	26	7	0,5	173	6	7	7	12
	10,2	17,6	10	1,0	220	7	10	10	17
	16,4	11	15	1,0	298	8	15	15	26
	24,6	7,4	21	1,5	386	11	21	21	38
	29,0	6	24	2,0	423	12	25	24	44

Table for PP

Foundation: 2207, 2208 DIN 16932 German association for welding

Use for: **4900**

1 bar on manometer: **59 N**

The standard value for heating element temperature is 210° C +/- 10° C.

The **smaller** the pipe wall the **higher** the temperature.

Additional to the given bead-up force and to the welding force the moving force of the support must be added !

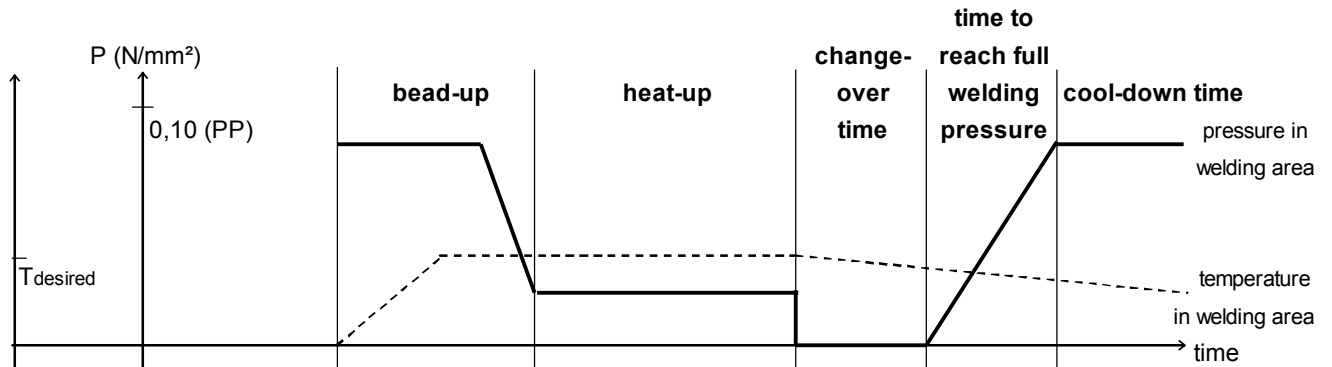

pipe diameter OD [mm]	pipe wall (s) [mm]	SDR	bead-up pressure [bar]	circular bead min. [mm]	heat-up time [s]	max. change-over time [s]	time to reach welding pressure [s]	welding pressure [bar]	cool-down time [min]
200	4,9	41	6	0,5	141	5	6	6	7
	6,2	33	7	0,5	162	6	7	7	10
	7,7	26	8	1,0	185	6	8	8	13
	11,4	17,6	12	1,0	237	7	11	12	19
	18,2	11	18	1,0	320	9	16	18	29
	27,4	7,4	26	2,0	411	11	23	26	42
	33,2	6	30	2,0	456	13	29	30	50
225	5,5	41	7	0,5	151	5	6	7	8
	6,9	33	9	0,5	173	6	7	9	12
	8,6	26	10	1,0	197	6	8	10	15
	12,8	17,6	15	1,0	255	7	12	15	21
	20,5	11	23	1,5	345	9	18	23	32
	30,8	7,4	32	2,0	437	12	26	32	47
	37,4	6	38	2,5	487	14	32	38	55
250	6,2	41	9	0,5	162	6	7	9	10
	7,7	33	10	1,0	185	6	8	10	13
	9,6	26	13	1,0	211	7	9	13	16
	14,2	17,6	18	1,0	272	8	13	18	23
	22,7	11	28	1,5	367	10	20	28	35
	34,2	7,4	40	2,0	463	13	29	40	51

Table for PP

Foundation: 2207, 2208 DIN 16932 German association for welding

Use for: **4900**

1 bar on manometer: **59 N**

The standard value for heating element temperature is 210° C +/- 10° C.

The **smaller** the pipe wall the **higher** the temperature.

Additional to the given bead-up force and to the welding force the moving force of the support must be added !

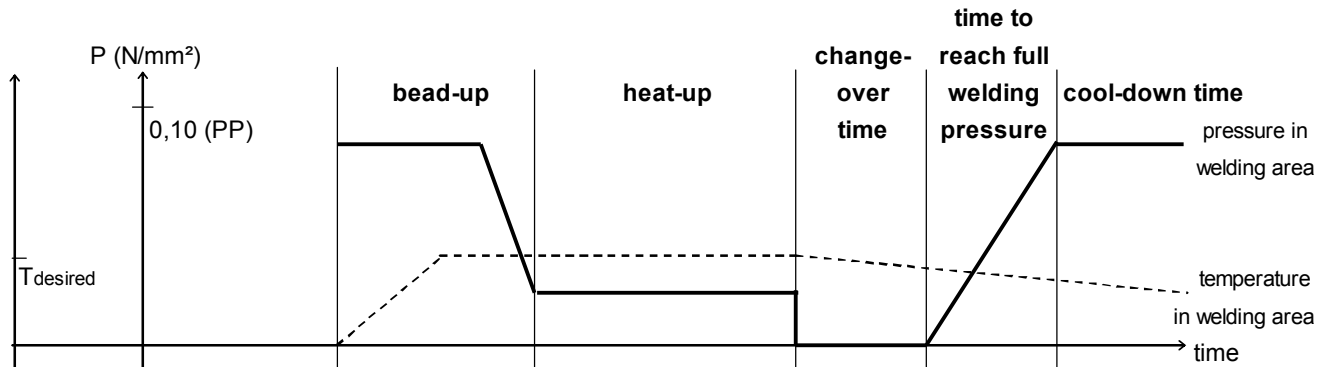

pipe diameter OD [mm]	pipe wall (s) [mm]	SDR	bead-up pressure [bar]	circular bead min. [mm]	heat-up time [s]	max. change-over time [s]	time to reach welding pressure [s]	welding pressure [bar]	cool-down time [min]
280	6,9	41	11	0,5	173	6	7	11	12
	8,6	33	13	1,0	197	6	8	13	15
	10,7	26	16	1,0	227	7	10	16	18
	15,9	17,6	23	1,0	292	8	14	23	26
	25,4	11	35	1,5	394	11	22	35	39
	38,3	7,4	50	2,5	493	14	33	50	57
315	7,7	41	13	1,0	185	6	8	13	13
	9,7	33	16	1,0	213	7	9	16	16
	12,1	26	20	1,0	246	7	11	20	20
	17,9	17,6	29	1,0	317	9	16	29	28
	28,6	11	44	2,0	420	12	24	44	44

① Remaining under the cool-down time for up to 50% is allowed under the following conditions:

- prefabrication under workshop conditions
- low additional pressure at unclamping
- no additional pressure during further cooling down
- load onto the workpieces only after being completely cooled down

Table for PVDF

Foundation: 2208, 2207 Part 15 German association for welding

Use for: **4900**

1 bar on manometer: **59 N**

The standard value for heating element temperature is 240° C +/- 8° C.

The **smaller** the pipe wall the **higher** the temperature.

Additional to the given bead-up force and to the welding force the moving force of the support must be added !

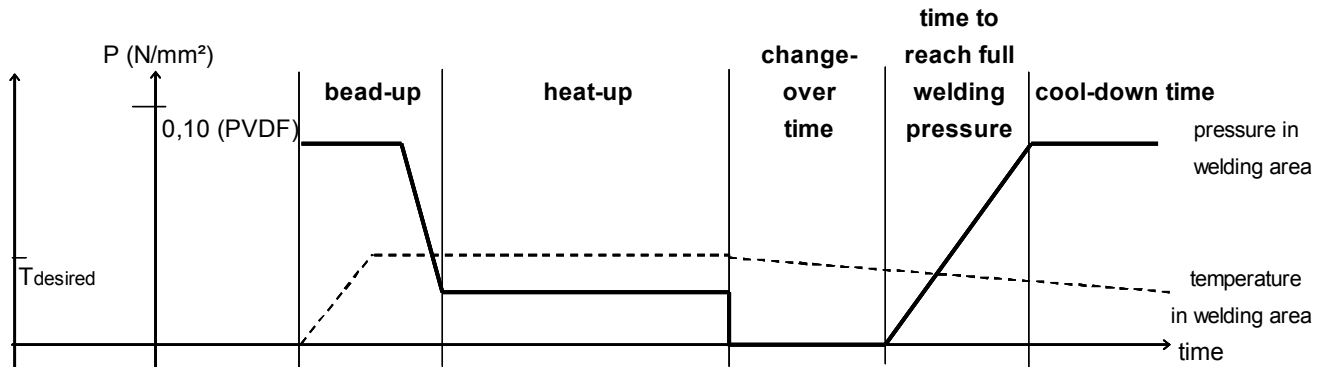

pipe diameter OD [mm]	pipe wall (s) [mm]	bead-up pressure [bar]	circular bead min. [mm]	heat-up time [s]	max. change-over time [s]	time to reach welding pressure [s]	welding pressure [bar]	cool-down time [min]
90	2,8	2	0,5	68	3	4	2	5,5
	4,3	2	0,5	83	3	4	2	7,0
	5,4	3	0,5	94	3	5	3	8,5
110	3,4	2	0,5	74	3	4	2	6,0
	5,3	3	0,5	93	3	5	3	8,5
	6,6	4	0,6	106	4	5	4	10,0
125	3,9	3	0,5	79	3	4	3	6,5
	6,0	4	0,6	100	4	5	4	9,0
140	4,3	4	0,5	83	3	4	4	7,0
	6,7	5	0,6	107	4	6	5	10,0
160	4,9	5	0,5	89	3	5	5	8,0
	7,7	7	0,7	117	4	6	7	11,0
180	5,5	6	0,5	95	4	5	6	8,5
	8,6	8	0,8	126	4	6	8	12,5
200	6,2	7	0,6	102	4	5	7	9,5
	9,6	10	1,0	136	4	7	10	13,5
225	6,9	9	0,7	109	4	6	9	10,5
	10,8	13	1,0	148	4	7	13	15,0
250	7,7	10	0,7	117	4	6	10	11,0
	11,9	16	1,1	159	4	8	16	16,5
280	8,6	13	0,8	126	4	6	13	12,5
315	9,7	16	1,0	137	4	7	16	13,5

7. Maintenance and repair

Goal of the chapter is:

- Keeping of the nominal state and the operation capacity of the machine.
- Increasing of the efficiency by avoiding non-planned outage.
- Efficient planning of the maintenance works and the maintenance tools.

7.1. Clamping elements

- For a long service life clean and grease regularly the threaded spindles and the joint parts which are used for clamping the pipes.

7.2. Planer

- Check the stress of the linkage in the planer and grease it regularly. Dismount the cover to get to the linkage.
- Do not lay the planer on its blades.
- The blades of the planer must be checked for sharpness. Wrong blades must be either turned over (double sided) or replaced (max. thickness of the shavings: 0.2 mm !).
- Check the working of the safety micro switch.

7.3. Storing

- The cylindrical waves of the basic machine are to be kept free from dirtiness and need to be covered with a thin oil film if they are not being used.
- Store dry.

7.4. Used hydraulic oil

Only use **HLPD 32**.

Features: protection against corrosion, resistance to ageing, abrasion-reducing additives, high carrying capacity and particulary water retending.



The hydraulic oil has to be handled properly and to be disposed of.

7.5. Checking the hydraulic oil level

- Remove the red screw at the top of the aggregate.
- Take out the oil dip rod, clean it and insert it again.
- The oil-level must be between the two markers.

7.6. Venting the hydraulic cylinders

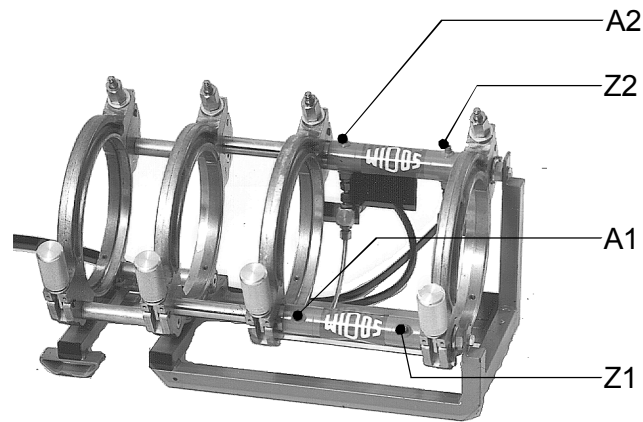

Venting the hydraulic cylinder is not required, if

- the hoses have been disconnected from the connection at the control unit because the remaining oil in the hose is being kept by valves and for this reason no air can enter.

Venting of the hydraulic cylinder is necessary, if

- there has been too little oil in the tank and air has been attracted.
- there were leaky parts in the hoses or connections.
- the hoses were unscrewed from the basic machine.
- Eliminate the cause of the air entrance.
- Open the machine completely.
- First loosen the lower venting screw (A1) for closing (lefthand side).
- Connect the transparent venting hose and insert into the collecting vessel.
- Close until there is no air in the venting hose, then screw on the venting screw.
- Repeat the same process at the upper venting screw (A2) for closing (left).
- Close the machine completely.
- First loosen lower venting screw (Z1) for opening (righthand side).
- Connect the transparent venting hose and insert into the collecting vessel.
- Open until there is no air in the venting hose, then screw on the venting screw.
- Repeat the same process at the upper venting screw (Z2) for opening (right).



The lower venting screws have always to be vented in the first position because there is a direct link between the upper and the lower cylinder.

- If there is still air in the lower cylinder this will ascent in the upper cylinder under pressure.

8. Transport

The machine can be transported either by means of two transport boxes or by one packing box.

- In each box holders are included which are suitable for each single element of the machine in order to avoid slipping.
- In both of the boxes there are partitions in which the component elements of the machine fit in such a way that they cannot be moved.
- Put the elements into the box in such a way that they are fitting in the holders.
- The hydraulic hoses at the basic machine should not be unscrewed (air penetration).
- Make sure that they are not being squeezed.
- Handle the machine with care.
- Do not tilt the hydraulic aggregate because oil may come out.
- Protect from heavy shocks and impacts.
- Make sure that the box cover is well closed.
- Care was taken to build the transport boxes according to lightweight construction.
- Be always careful while using automatic handling and carrying machines.





During the transport of the machine there may be cold weldings between the piston rod and the eyes of the planer shell. These spots on the piston rod may damage the sealing.

- Therefore the eyes must be lubricated with PTFE-spray before transport !

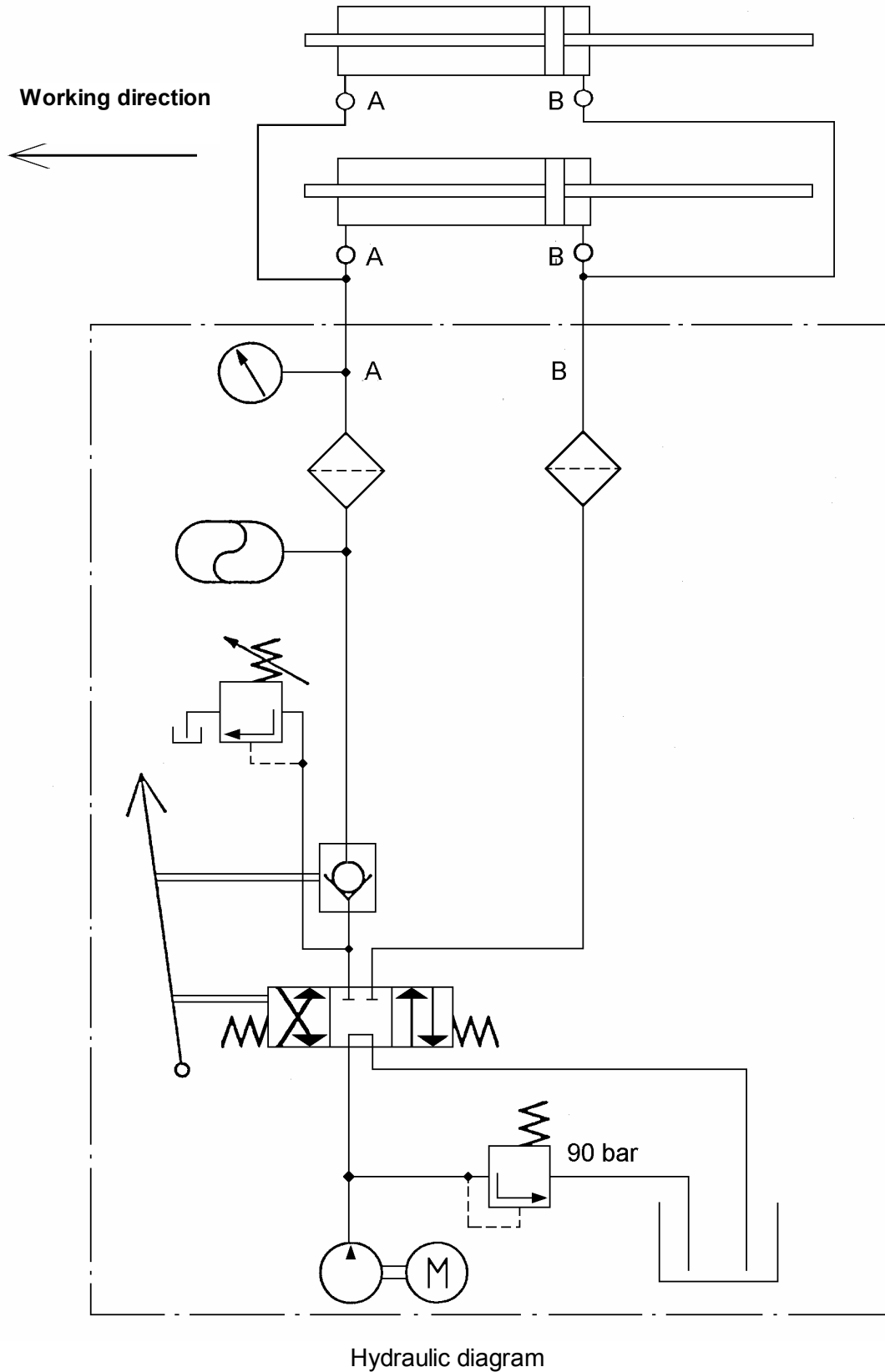
9. Electric and hydraulik diagrams

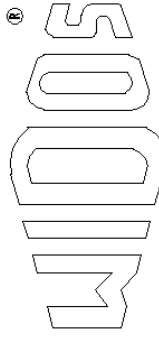

	WIDOS GmbH Kunststoffschweißtechnik Plastic Welding Technology	Einsteinstrosse 5 D-71254 Ditzingen Tel.: +49 (0) 7152 / 9939-0 Fax: +49 (0) 7152 / 9939-40 http://www.widos.de	<h1 style="font-size: 2em;">Circuit diagram</h1>	project title W 4900 – Manual machine type W 4900 – Manual ab 2009 Number of sheets 3 Date 09.10.09	= 100KU + 1001 sheet number continuation sheet Number of sheets 3
manufacturer 		project title W 4900 – Manual Job number 00000 drawing number W4900MANUELLO9		W 4900 – Manual ab 2009 cover sheet	
commission 00000 Number of sheets 3 date of print 12.10.09 project status 09. Okt. 2009	Date 09.10.09 draughtsman A.F.				

Copying or dissemination only allowed by our written approval.

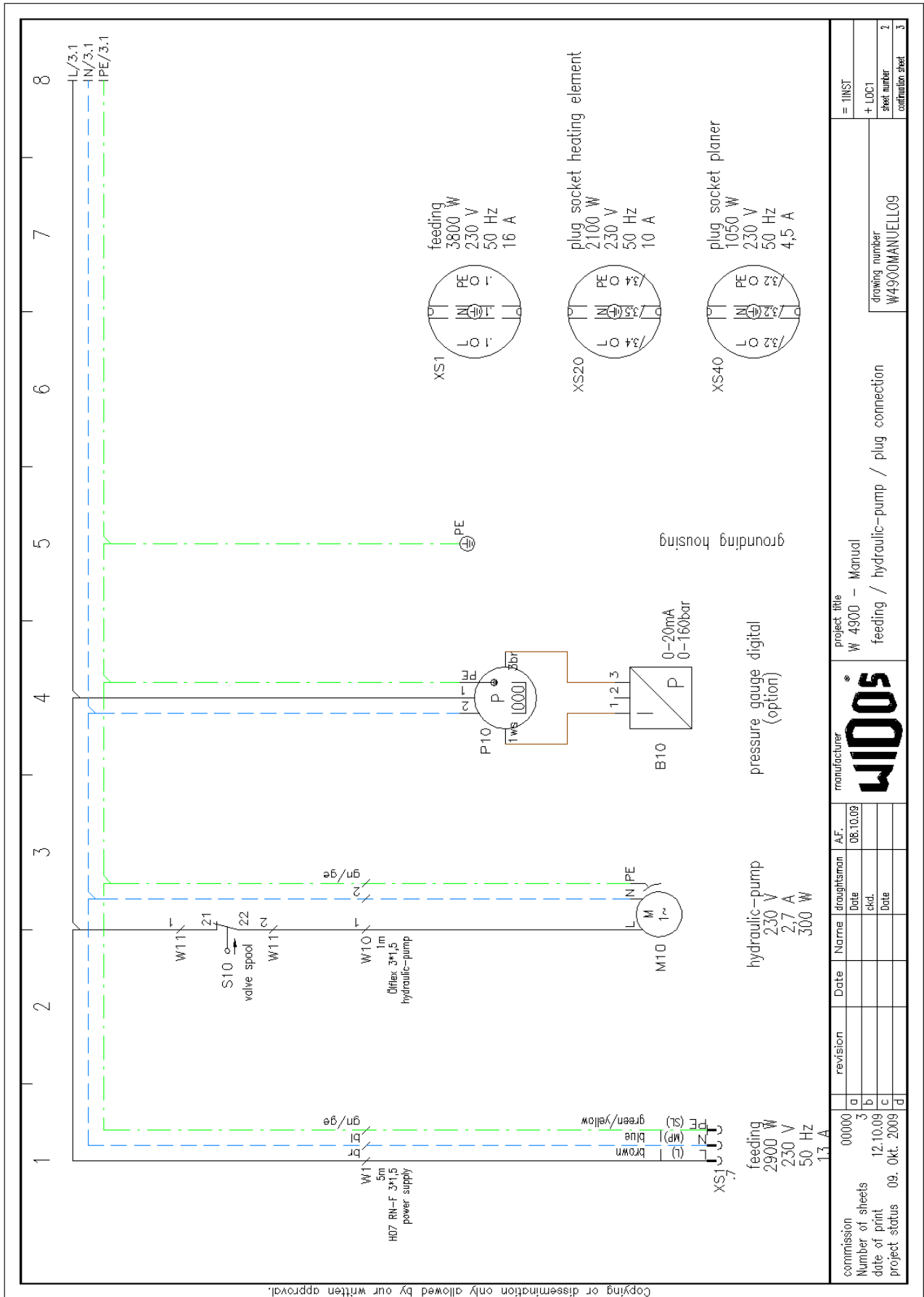

Copying or dissemination only allowed by our written approval.

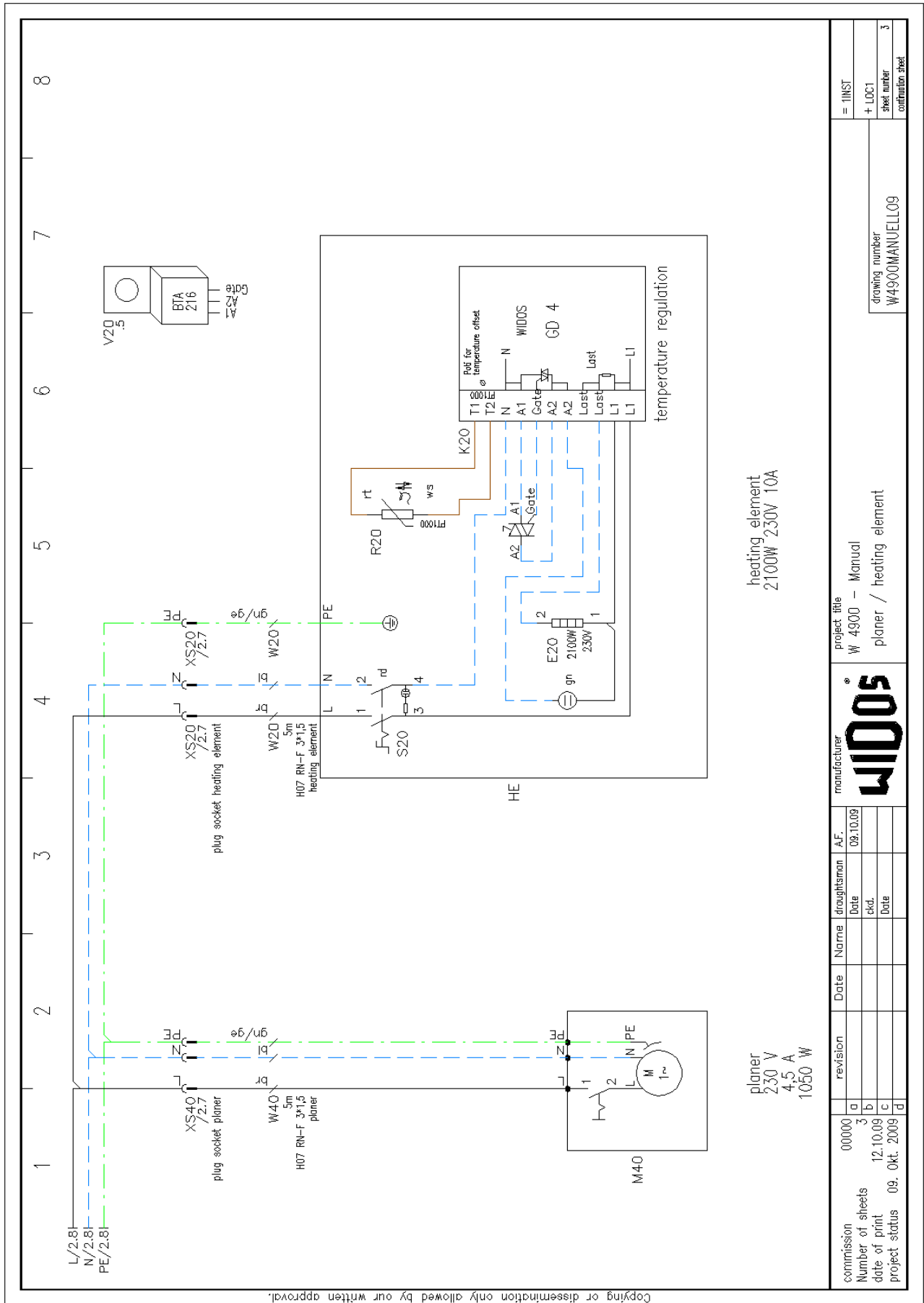

heating element
2100W 230V 10A

planer
230 V
4.5 A
1050 W

commission	00000	revision		manufacturer	project title	
Number of sheets	3	Date		WIDOS	W 4900 - Manual	
date of print	12.10.09	draughtsman	AF.		planer / heating element	
project status	09. Okt. 2009	Date	09.10.09		drawing number	
					W4900MANUELLO9	
					sheet number	
					3	
					continuation sheet	

10. Spare parts list

10.1. Basic machine

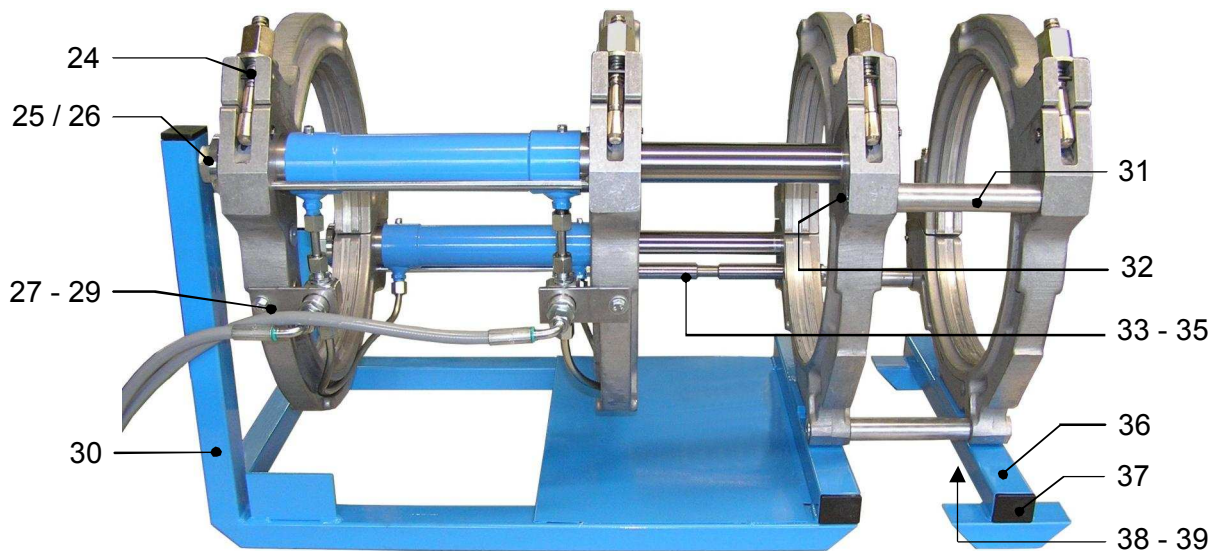
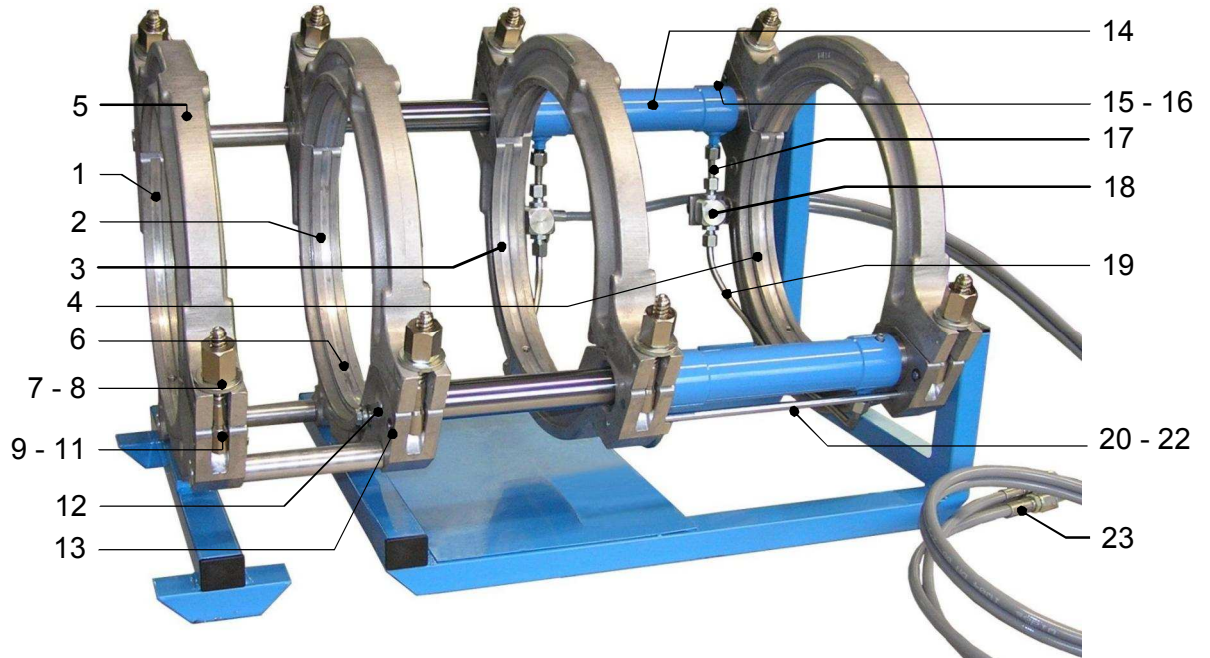

Basic machine WIDOS 4900

Pos.	Name	Piece	Art.-No.
1	Outer clamp, fixed	1	216101
2	Inner clamp, fixed	1	216102
3	Inner clamp, movable	1	216103
4	Outer clamp, movable	1	216104
5	Upper clamp	4	214105
6	Thread insert M 6	8	GEW-M6
7	Nut	8	091109
8	Thrust washer M 14 DIN 6340	8	6340N
9	Threaded spindle	8	091108
10	Rivet	8	091111 216111
11	Lock washer size 7 DIN 6799	8	6799G
12	Flat head screw M 12x20 DIN 7991	2	7991L020
13	Lock washer size 7 DIN 6799	8	6799G
14	Hydraulic cylinder	2	216106
	Gasket set for cylinder	2 set	D216106
15	Retainer ring 6x9,3x1	4	D6x9,3
16	Cylinder head screw M 6x10 DIN 912	4	0912F010
17	Hydraulic hose (40 mm)	2	216113
18	Filter	2	V092114
19	Hydraulic hose (320 mm)	2	216112
20	Pull shaft	2	216107
21	Counter nut M 8 DIN 985	2	0985H
22	Washer M 8 DIN 125	2	0125H
23	Hose bunch	1	VSCHL4900
24	Spiral pin 4x40 DIN 7343	4	7343D040
25	End bolt	2	091117
26	Thrust washer	2	216133
27	Holder for filter	2	092120
28	Washer M6 DIN 9021	2	9021F
29	Hexagon-head screw M 6x16 DIN 933	2	0933F016
30	Basic frame	1	216118
	Floor plate for basic frame	1	2161182
31	Shaft	3	091131
32	Flat head screw M 12x30 DIN 7991	6	7991L030
33	Tear off bar for heating element	1	216503
34	Hexagon-head screw M 8x12 DIN 933	2	0933H012
35	Washer M 8 DIN 125	2	6340H
36	Support	1	216141
37	Protective cap 40 x 30	6	J0203
38	Pan-head screw M 8x25 DIN 912	3	0912H025
39	Protective cap, round SL 20x1-2	3	J0215
40	Pan-head screw M 10x20 DIN 912	2	0912J020

Basic machine WIDOS 4900

Pos.	Name	Piece	Art.-No.
41	Washer M 10 DIN 125	2	0125J
42	Protective cap, round SL 22x102	2	J0216
43	Protective cap, round SL 14x1-2	1	J0212
--	Reducer inserts OD 90 - 280	1 set	3808...*
--	Reduction inserts OD 90 - 280	1 set	3818...*
--	Cylinder head screw M 6x30 DIN 912 (to OD 90-250)	8	0912F30X
--	Cylinder head screw M 6x25 DIN 912 (to OD 280)	8	0912F25X
--	Hydraulic oil	2 l	HLPD35
--	Tool bag for 10 parts	1	ZRW
--	Allan key angled size 3 DIN 911 B	1	ZIG03
--	Allan key angled size 6 DIN 911 B	1	ZIG06
--	Allan key angled size 7 DIN 911 B	1	ZIG07
--	Allan key angled size 8 DIN 911 B	1	ZIG08
--	Allan key with T-grip size 4	1	ZIT04
--	Allan key with T-grip size 5	1	ZIT05
--	Allan key with T-grip size 7	1	ZIT07
--	Socket spanner size 27	1	ZRS27
--	Transport case	1	TV4800
	* For ordering necessarily give the dimensions !		

10.2. Planer

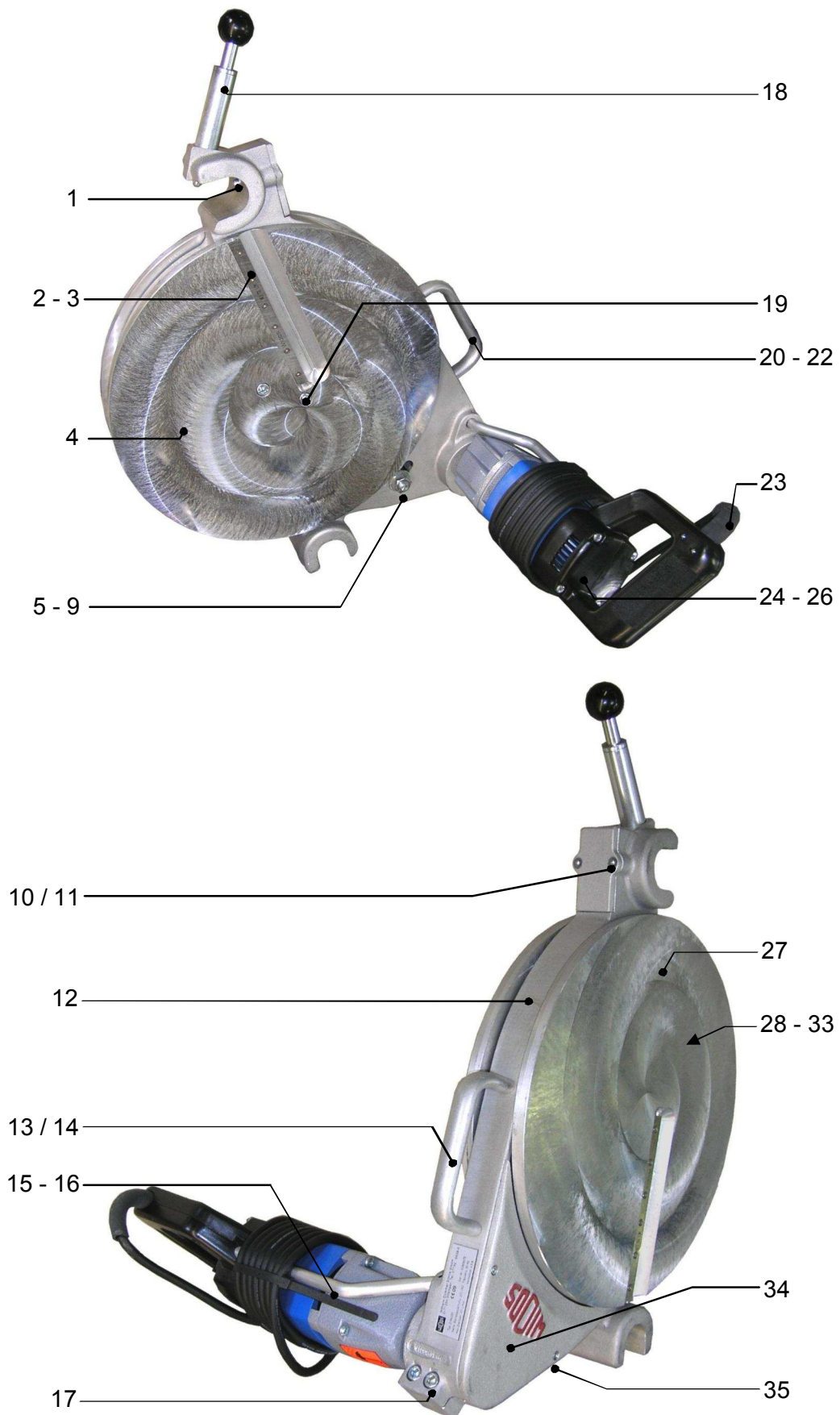

Planer WIDOS 4900			
Pos.	Name	Piece	Art.-No.
1	Limit switch, complete	1	ES0102
2	Knife	2	MES170
3	Flat-head screw M 3x8 with Torx-drive	12	0965C008TX
4	Disc planer, righthand	1	216402
5	Ball bearing	2	L6001Z
6	Chain tensioner screw	1	0914101
7	Hexagon nut M 12 DIN 934	1	0934L
8	Washer M 12 DIN 125	3	0125L
9	Washer M 12 DIN 134	1	0134L
10	Switch cover for planer	1	091420
11	Flat-head screw M 5x12 DIN 7991	2	7991E012
12	Fastener for planer	1	216401
13	Bow grip	1	BG56520
14	Pan-head screw M 6x16 DIN 912	2	0912F016
15	Cover tube	1	216405
16	Grub screw M 4x8 DIN 913	1	0913D008
17	Pan-head screw M 8x30 DIN 912	2	0912H030
18	Locking bolt complete	1	091422
19	Pan-head screw M 8x30 DIN 912	2	0912H030
20	End sleeve for strands with ring M 4	1	EA05425
21	Tooth lock washer M 4 DIN 6797	1	6797D
22	Lens head screw M 4x8 DIN 7985	1	7985D008
23	Connecting cable with plug	1	EK3220
24	Driving motor 1050 W, 230V	1	AMBF16
25	Motor switch	1	ESMBF16
26	Collector carbon	1 set	EKMBF16
27	Disc planer, lefthand	1	216403
28	Chain wheel, small (11 teeth)	1	K38011
29	Chain 3/8" (103 links)	1	K38103
30	Chain joint	1	KSCH38
31	Ball bearing	1	L6013
32	Flat-head screw M 6x12 DIN 7991	4	7991F012
33	Chain wheel, large 3/8" x 7/32"	1	091406
34	Cover	1	216404
35	Pan-head screw M 4x16 DIN 912	2	0912D016
--	Torx-screw driver T10	1	ZT10

10.3. Hydraulic aggregate

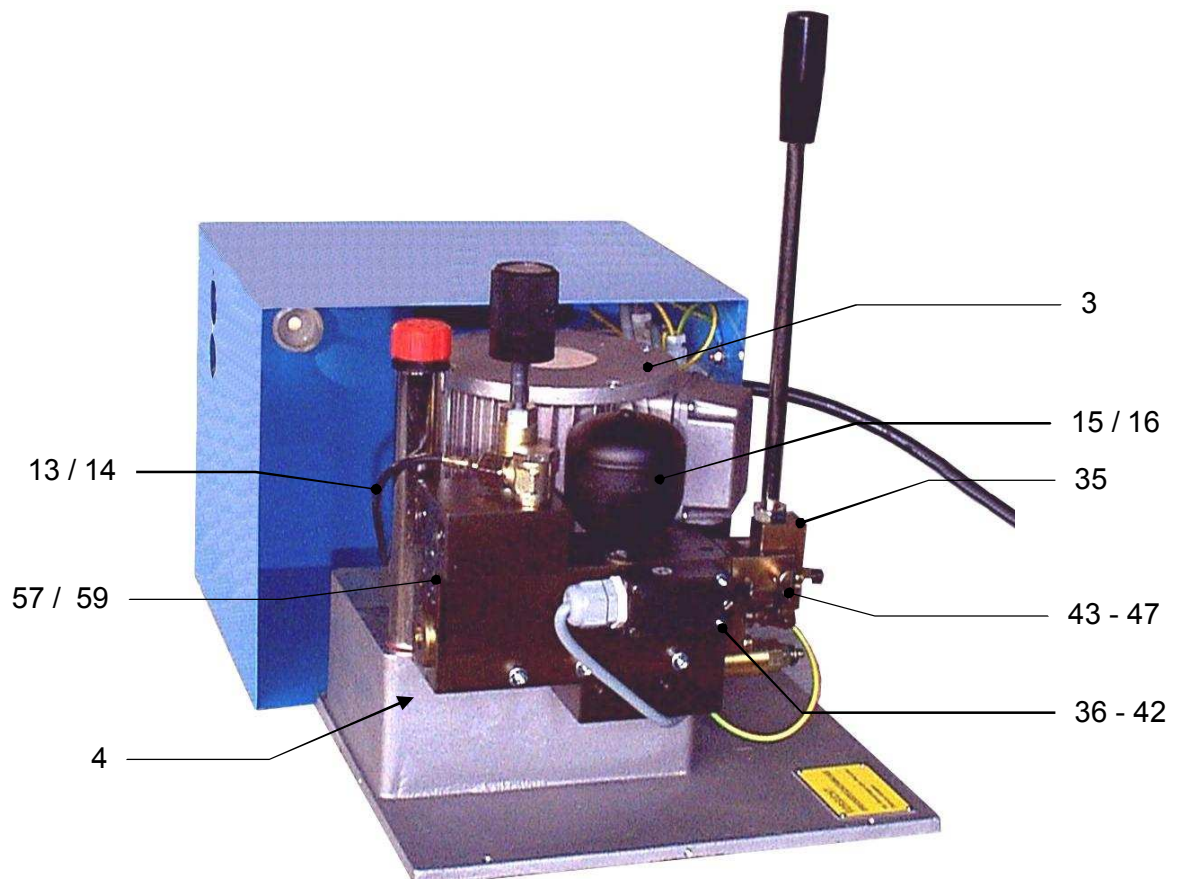
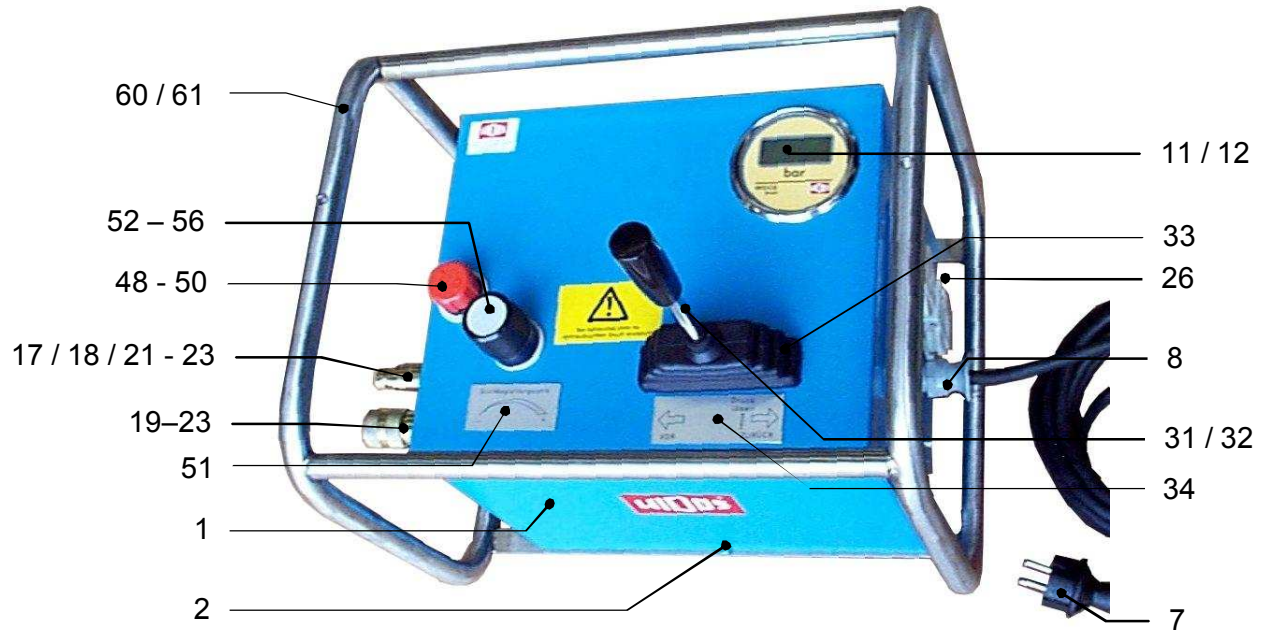

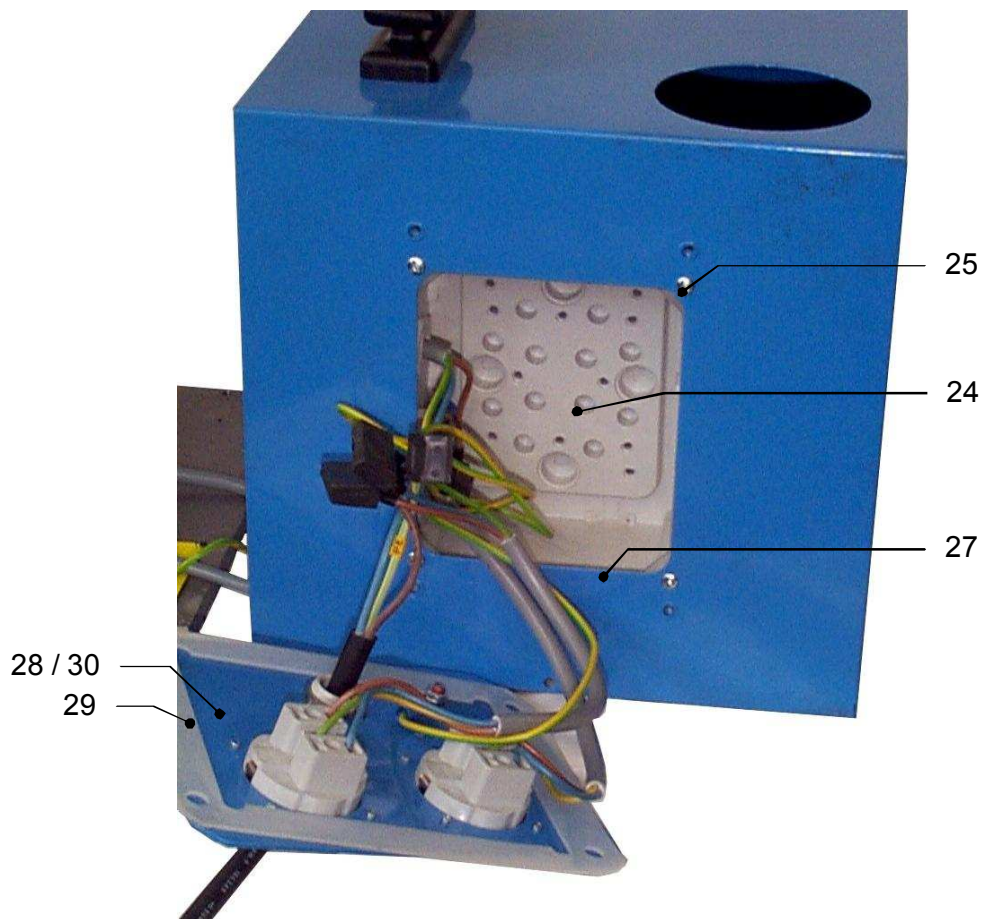
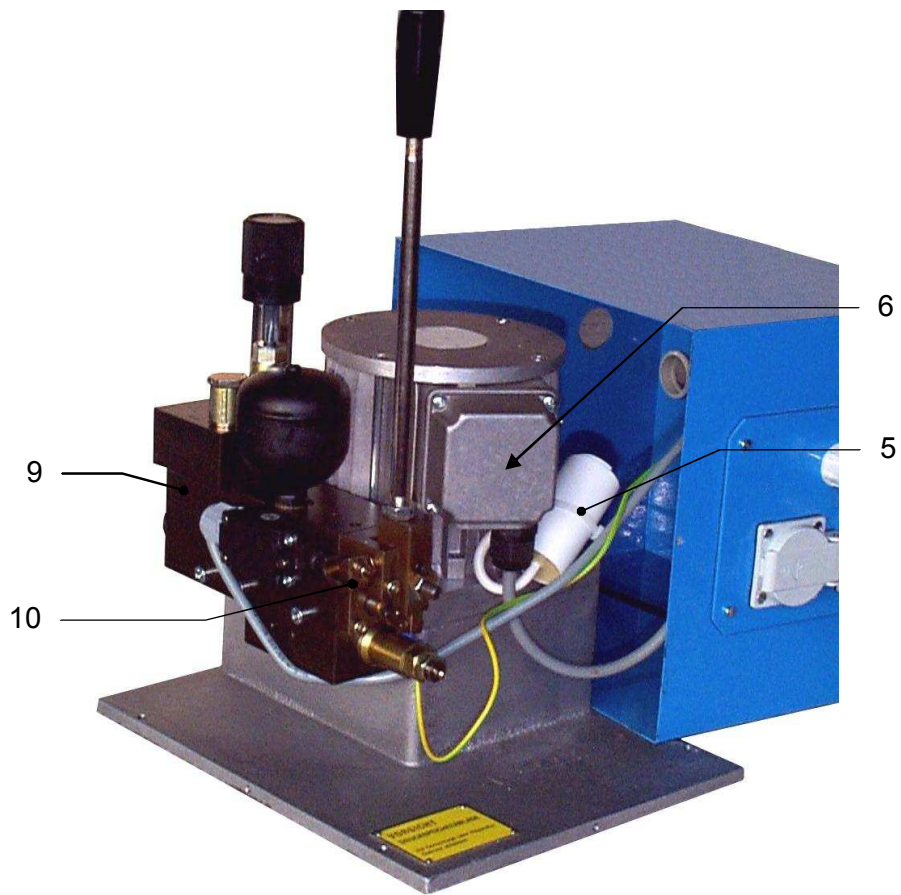

Hydraulic Aggregate WIDOS 4900

Pos.	Name	Piece	Order no.
1	Cover	1	1010021
2	Pan-head screw M4x12 DIN 912	4	0912D012
3	Motor	1	on request
4	Pump 1.9 l	1	102103
5	Capacitor 12,5 µF	1	EK12220
6	Universal RC - link	1	EE0104
7	Connection cable with plug	1	EK32220
8	Screwed connection PG 13.5	1	EV0113
9	Valve	1	on request
10	Pan-head screw M6x45 DIN 912	4	0912F045
11	Pressure gauge	1	101004D
12	Screwed connection of pressure gauge	1	V042314
13	Mini hose	1	on request
14	Hose screwing	1	101008
15	Accumulator	1	101006
16	Ring for sealing 16x22.7x1.5	1	D16x22,7
17	Coupling box, flat packing	1	VMU14
18	Synthetic cap for VMU14	1	VKM14
19	Coupling plug, flat packing	1	VST14
20	Synthetic cap for VMST14	1	VKS14
21	Ring for sealing 16x22.7x1.5	2	D16x22,7
22	Screwed connection	2	V101024
23	O-ring 19x1,5	2	D19x1,5
24	Distributor box	1	on request
25	Pan-head screw M4x10 DIN 912	2	0912D010
26	Socket	2	EST0701
27	Seal, inside	1	1010024
28	Side part	1	1010022
29	Seal, outside	1	1010023
30	Pan-head tapping screw 3.5 x 20	4	7971C020
31	Valve lever	1	101013
32	Cylinder knob M10	1	101033
33	Bellows	1	101035
34	Plate "Release pressure"	1	SCHD-L
35	Hexagon nut M10 DIN 934	1	0934J
36	Pressure switch	1	ESEK103
37	Pan-head screw M4x25 DIN 84	2	0084D025
38	Angle for pressure switch	1	on request
39	Washer M4 DIN 125	1	0125D
40	Pan-head screw M 4x10 DIN 912	1	0912D010
41	Set screw M5x10 DIN 915	1	0915E010
42	Bolt	1	101038
43	Adjusting screw	1	101036

Hydraulic Aggregate WIDOS 4900

Pos.	Name	Piece	Order no.
44	Hexagon nut M6 DIN 934	3	0934F
45	Plug-in element P83-1/2"x3/16"	1	101043
46	Bearing block	1	on request
47	Pan-head screw M5x45 DIN 912	2	0912E045
48	Control knob for pressure setting	1	101022
49	Bush	1	101047
50	Set screw	1	101050
52	Oil dipstick	1	101021
53	Hydraulic oil	1 l	HLPD35
54	Filler neck	1	101026
55	Copper ring 14x18x1.5 DIN 7603	1	D14x18
56	Cable bushing Kt21	2	EKT21
57	Leading-in for tubes size 22	2	EKT22
58	Sinter-filter 15x8 41180	2	101045
59	O-ring 16x2	2	D16x2
60	Protective mounting	1	101042
61	Pan-head screw M6x16 DIN 912	4	0912F016

10.4. Heating element

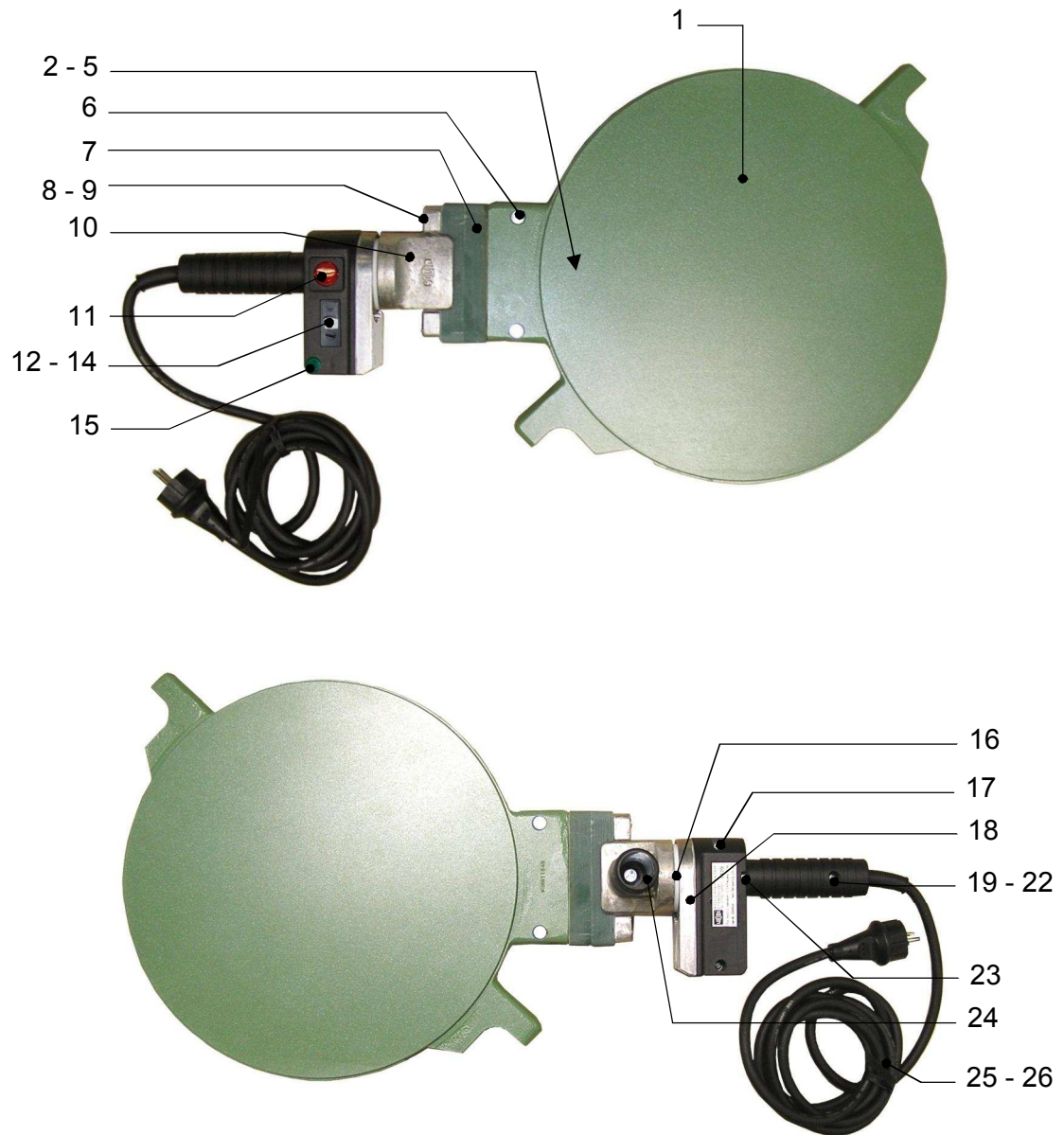

Heating element WIDOS 4900

Pos.	Name	Piece	Art.-No.
1	Heating element H 4900, 230 V	1	H4900D
	Heating plate new	1	HP4900D
	Heating plate for change	1	HPT4900D
2	Temperature probe PT1000	1	H09082
3	Probe holder	1	235037
4	Toothedlock washer 14,5 DIN 6797	1	6797D
5	Oval-head screw M 4x8 DIN 7985	2	7985D006
6	Tapped bushing	2	HGEW-M6
7	Insulator plate	2	H0902
8	Spring washer M6 DIN 127B	2	0127F
9	Pan-head screw M 6x75 DIN 912	2	0912F075
10	Grip joining piece	1	H0909
11	Rocker switch, red lightet	1	H0903
12	Thermo regulator GD4	1	H0908230D
13	Window for grip case	1	H09071
14	Knob with slot	1	H09075D
15	Control lamp, green	1	H2105
16	Teflon-conical nipple for heating element	1	H09091
17	Oval-head screw C4,2x19 DIN 7981	3	7981D019
18	Heat sink with TRIAC BTA 216	1	H09081
19	Handle case	1	H0907
20	Lustre terminal	1	on request
21	Oval-head screw 2,9x13 DIN 7981	2	7981C013
22	Strain relief	1	EK3220
23	Pan-head screw M 4x70 DIN 912	3	0912D070
24	Grip	1	H0906
25	Antikink grommet	1	EKT08
26	Connecting cable with plug	1	EK3220

10.5. Reception box

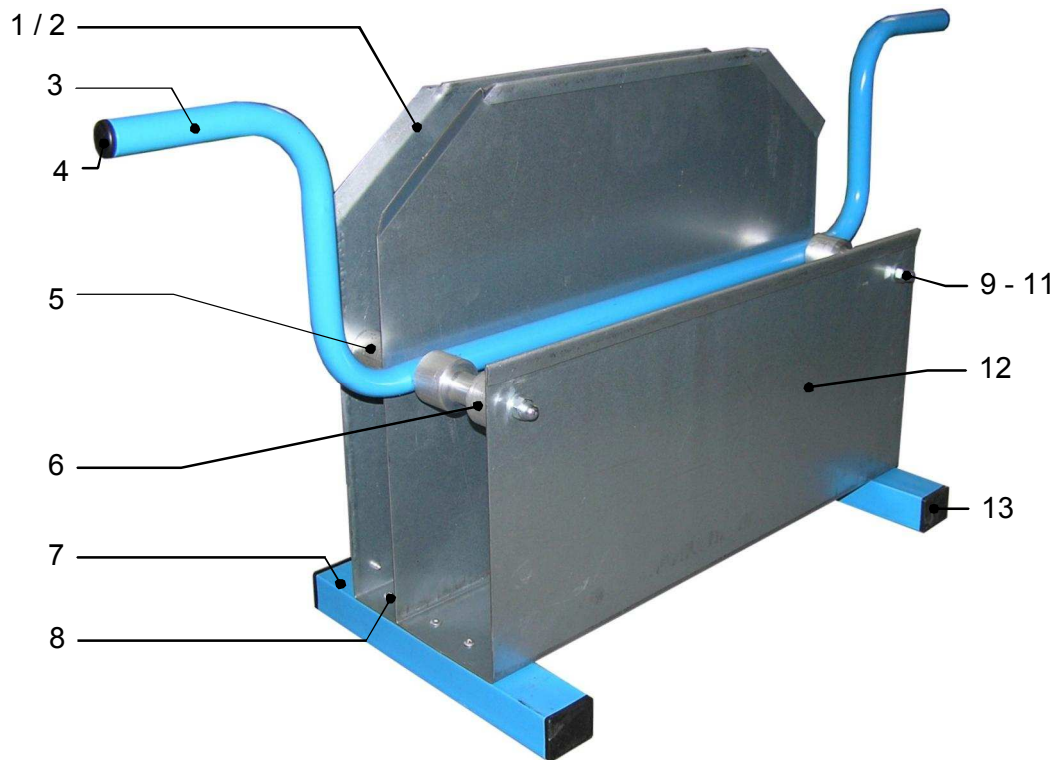

Reception box WIDOS 4900

Pos.	Name	Piece	Art.-No.
1	Heat absorbing steel sheet	1	214528
2	Insertion for heating element	1	214523
3	Stirrup	1	214527
4	Fitting cab Ø20x2	2	J5401
5	Spacing bolt for heating element	2	214525
6	Spacing bolt for planer	2	216524
7	Foot-mounting	2	214521
8	Blind rivet 4x10 DIN 7337	8	7337D010
9	Hexagon bolt M 8x160 DIN 933	2	0933H180
10	Hexagon domed cap nuts 6AU M 8 DIN 1587	2	1587H
11	Washer M 8 DIN 125	2	0125H
12	Insertion for planer	1	214522
13	Fitting cap 40x30x2	4	J0203

11. Declaration of conformity

in the sense of the EC-guideline, EG-MRL 2006/42/EG

Corporation

WIDOS GmbH
Einsteinstr.5
D- 71254 Ditzingen- Heimerdingen

declares under own responsibility that the product

Plastic welding machine
WIDOS 4900

to which this declaration refers corresponds to the following norms and norming documents:

1. DIN EN ISO 12100 – 1 und 2 (replacement for DIN EN 292 part 1 and 2)
Safety of machines, basic terminology, gen. design guidelines
2. DIN EN 60204.1
Electric equipment of industrial machines
3. DIN EN 4413
Safety technology requirements at fluid technical devices and components
4. EN 60555, EN 50082, EN 55014
Electro-magnetic resistance

The technical documentation is completely available.

The above-mentioned company will provide the following technical documentation for inspection:

- test certificate
- other technical documentation

Ditzingen - Heimerdingen, the 02.11.11

Marting Dommer (Technical director)