

auro...

PVC-U

DE/EN // STAND/ : 2021.02

Als zweitältester Massenkunststoff der Welt hat sich PVC-U in den unterschiedlichsten Anwendungen bewährt. Seit Mitte der 1930er Jahre gibt es Formteile aus PVC-U. Diese zeichnen sich unter anderem durch ihre Trinkwassereignung und eine hohe chemische Beständigkeit aus.

Eigenschaften

- Hohe chemische Beständigkeit
- Hervorragende Verarbeitbarkeit

Werkstoff

Polyvinylchlorid (PVC) ist ein amorpher thermoplastischer Kunststoff, RAL 7011 Eisengrau

Verbindungstechnik

- Klebung
- Flanschverbindung

As the second-oldest mass plastic in the world, PVC-U has been approved and tested in various applications. Since the mid-1930s, fittings made of PVC-U have been used. They convince with very good properties for the usage in drinking water and by their high chemical resistance.

Properties

- High chemical resistance
- Excellent processing capability

Material

Polyvinyl Chloride (PVC) is an amorphous thermoplastic polymer, RAL 7011 Iron grey

Joining technology

- Bonding
- Flange connection



Rohre
Pipes

PVC 3



Formteile
Fittings

PVC 4

Bögen, Winkel
Bends, Elbows

PVC 5

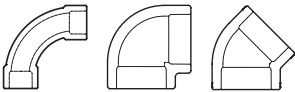

Formteile mit Kunststoff-Gewinde
Fittings with plastic-thread

PVC 22

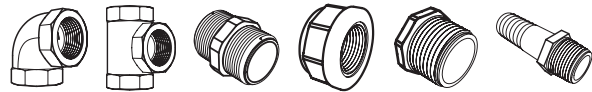

T-Stücke, Abzweige
Tee's, Branches

PVC 6

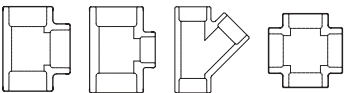

Kugelhähne
Ball valves

PVC 24

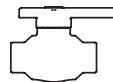

Reduktionen, Muffen, Kappen
Reducers, Sockets, Caps

PVC 8

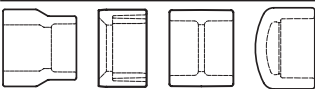

Ventile
Valves

PVC 25



Übergänge
Transitions

PVC 11

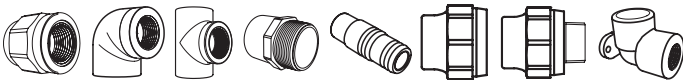

Clipse
Clips

PVC 28



Verschraubungen
Unions

PVC 15

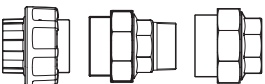

Zubehör
Accessories

PVC 29

Flanschverbindung
Flange connection

PVC 20

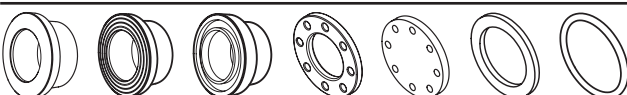

PVC-U Druckrohr

Beschreibung

PVC-U Druckrohr, homogen, einschichtig, SDR13,6/21, ähnlich RAL 7011 Eisengrau. Einsetzbar für Trinkwasser, Abwasser und industrielle Anwendungen.

Werkstoff

PVC-U (weichmacherfreies Polyvinylchlorid) ohne Füllstoffe. Das Material entspricht den Anforderungen der aktuellen KTW-Leitlinie des Umweltbundesamtes (UBA).

Geometrische Eigenschaften

Abmessungen und Toleranzen entsprechend DIN 8061/62 (Druckrohre), DIN EN ISO 1452 (Wasserversorgung und Abwasserleitung), DIN EN ISO 15493 (Industrie).

Betriebsdruck

SDR13,6 = PN16 (20°C/1,6 MPa)

SDR21 = PN10 (20°C/1,0 MPa)

Ausführung

Alle Rohre mit glatten Enden.

Zertifizierung

PVC-U Rohre unterliegen regelmäßigen internen und externen Qualitätskontrollen. ZP 1.1.1 der DIN CERTCO und DVGW GW 335-A1.

Lieferung

In 5 m Stangen; lose gepackt. Andere Längen auf Anfrage. Abgabe erfolgt nur in kompletten Rohrlängen und Verpackungseinheiten (VEs).

PVC-U pressure pipe

Description

PVC-U Pressure pipe, homogeneous single-layer, SDR13.6/21, similar to RAL 7011 Iron grey.

Useable for drinking water, drainage water and industrial applications.

Material

PVC-U (unplasticized Polyvinylchloride) without fillers. The material complies with the requirements of the KTW guideline of the German Federal Environmental Agency (UBA).

Geometric Properties

Dimensions and tolerances according to DIN8061/62 (Pressure pipes), DIN EN ISO 1452 (Water supply and drainage water), DIN EN ISO 15493 (Industrial).

Operating pressure

SDR13.6 = PN16 (20°C/1.6 MPa)

SDR21 = PN10 (20°C/1.0 MPa)

Type

All pipes with plain ends.

Certification

PVC-U pipes succumb frequent internal and external quality controls. ZP 1.1.1 of DIN CERTCO and DVGW GW 335-A1.

Delivery

In 5 m rods; loosely packed. Other lengths on request. Supply only in complete lengths and packing units (PU's).

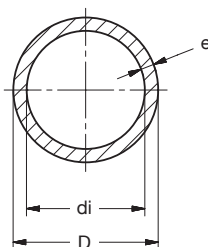
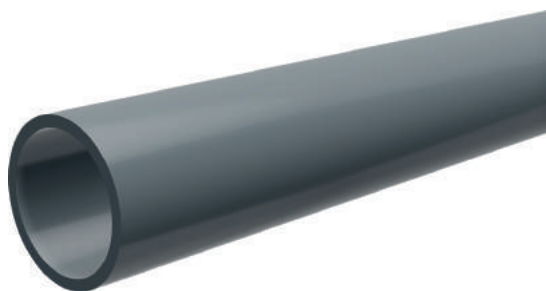

PVC-U Druckrohr **PN16** SDR13,6 grau 5m
PVC-U Pressure pipe **PN16** SDR13.6 grey 5m

Art Nr	D	e	di	SDR	L	KG	VE1	VE2
Art No	[mm]		[mm]		[m]		PU1	PU2
1112 0550 32	16	1,2	13,6	13,6	5	0,09	5	2400
1112 0650 32	20	1,5	17,0	13,6	5	0,14	5	2500
1112 0750 32	25	1,9	21,2	13,6	5	0,22	5	2400
1112 0850 32	32	2,4	27,2	13,6	5	0,35	5	1015
1112 0950 32	40	3,0	34,0	13,6	5	0,53	5	1105
1112 1050 32	50	3,7	42,6	13,6	5	0,82	5	1075
1112 1150 32	63	4,7	53,6	13,6	5	1,31	5	545
1112 1250 32	75	5,6	63,8	13,6	5	1,85	5	500
1112 1350 32	90	6,7	76,6	13,6	5	2,64	5	370
1112 1450 32	110	8,1	93,8	13,6	5	3,91	5	300
1112 1550 32	125	9,2	106,6	13,6	5	5,04	5	190
1112 1650 32	140	10,3	119,4	13,6	5	6,30	5	165
1112 1750 32	160	11,8	136,4	13,6	5	8,23	5	140
1112 1850 32	180	13,3	153,4	13,6	5	10,44	5	115

PVC-U Druckrohr **PN16** SDR13,5 transparent 5m
PVC-U Pressure pipe **PN16** SDR13.5 transparent 5m

Art Nr	D	e	di	SDR	L	KG	VE1
Art No	[mm]		[mm]		[m]		PU1
192 017 104	12	1,0	10,0	13,5	5	0,06	5
192 017 105	16	1,2	13,6	13,5	5	0,09	5
192 017 106	20	1,5	17,0	13,5	5	0,14	5
192 017 107	25	1,9	21,2	13,5	5	0,21	5
192 017 108	32	2,4	27,2	13,5	5	0,34	5
192 017 109	40	3,0	34,0	13,5	5	0,53	5
192 017 110	50	3,7	42,6	13,5	5	0,81	5
192 017 111	63	4,7	53,6	13,5	5	1,29	5

PVC-U Druckrohr **PN10** SDR21 transparent 5m
PVC-U Pressure pipe **PN10** SDR21 transparent 5m

Art Nr	D	e	di	SDR	L	KG	VE1
Art No	[mm]		[mm]		[m]		PU1
192 017 082	25	1,5	22,0	21	5	0,17	5
192 017 083	32	1,9	28,4	21	5	0,26	5
192 017 084	40	1,9	36,2	21	5	0,37	5
192 017 085	50	2,4	45,2	21	5	0,55	5
192 017 086	63	3,0	57,0	21	5	0,85	5
192 017 087	75	3,6	67,8	21	5	1,22	5
192 017 088	90	4,3	81,4	21	5	1,75	5
192 017 089	110	5,3	99,4	21	5	2,61	5

PVC-U Druckrohr **PN10** SDR21 grau 5m
PVC-U Pressure pipe **PN10** SDR21 grey 5m

Art Nr	D	e	di	SDR	L	KG	VE1	VE2
Art No	[mm]		[mm]		[m]		PU1	PU2
1111 0850 32	32	1,9	28,2	21	5	0,28	5	1015
1111 0950 32	40	1,9	36,2	21	5	0,36	5	1105
1111 1050 32	50	2,4	45,2	21	5	0,56	5	1075
1111 1150 32	63	3,0	57,0	21	5	0,87	5	545
1111 1250 32	75	3,6	67,8	21	5	1,24	5	500
1111 1350 32	90	4,3	81,4	21	5	1,77	5	370
1111 1950 32	200	9,6	180,8	21	5	8,64	5	115
1111 2050 32	225	10,8	203,4	21	5	10,91	5	55
1111 2150 32	250	11,9	226,2	21	5	13,34	5	55
1111 2250 32	280	13,4	253,2	21	5	16,84	5	40
1111 2350 32	315	15,0	285,0	21	5	21,15	5	40

PVC-U Formteile grau

gespritzt, für Druckrohrleitungen

PVC-U Fittings grey

injection moulded, for pressure pipe systems

Werkstoff

PVC-U (Polyvinylchlorid ohne Weichmacher), RAL 7011 Eisengrau. Das Material entspricht den Anforderungen der aktuellen KTW-Leitlinie des Umweltbundesamtes (UBA).

Geometrische Eigenschaften

Kleb- und Gewindeformteile in Anlehnung an DIN EN ISO 1452-3. Erfüllt werden zudem die Anforderungen der DIN CERTCO ZP 12.1.10. Toleranzen bei den Z-Maßangaben sind abhängig von der Dimension. Bis d/D 160 = +/- 3 mm. Ab d/D 180 = +/- 10 mm.

Kleb-Verbindung

Kleb- und Übergangsformteile sind geeignet zum Verbinden von PVC-U Röhren, deren Außendurchmesser-Toleranzen der DIN 8062 bzw. ISO 11922-1 entsprechen.

Gewinde-Verbindung

Die Anschlussgewinde der B-R Übergangsformteile mit Verstärkungsring entsprechen den Normen DIN EN 10226 bzw. ISO 7 [Innengewinde (IG) = zylindrisch, Außengewinde (AG) = keglig].

Die Innengewinde der B-R Gewindeformteile ohne Verstärkungsring sind kegelig entsprechend der ISO 7 ausgeführt.

Das Eindichten von PVC-U Gewindeteilen ist ausschließlich mit PTFE-Band vorzunehmen.

Hanf und Dichtpaste sind ungeeignet und dürfen nicht verwendet werden!

Betriebsdruck

Der zulässige Druck ist der jeweiligen Modell-Maßtabelle zu entnehmen. Sofern keine andere Angabe: Richtwert für Klebformteile: PN16 = 16 bar bei 20°C (Wasser).

Richtwert für Übergangs-/Gewindefittings und Verschraubungen: PN10 = 10 bar bei 20°C (Wasser).

Klebstoff

Für die Herstellung von Klebverbindungen ist die Verwendung eines Klebstoffs auf Basis THF unbedingt erforderlich. Unsere diesbezügliche Verlegeanleitung basiert auf der Verwendung von TANGIT-Klebstoff.

Kleblängen

In den Maßtabellen dieses Kataloges sind die Kleblängen nicht gesondert ausgewiesen. Diese sind bei Bedarf generell der nachfolgenden Tabelle zu entnehmen.

Lieferung

Abgabe erfolgt nur in kompletten Verpackungseinheiten (VE's).

Material

PVC-U (Polyvinyl Chloride unplasticised), RAL 7011 Iron grey. The material complies with the requirements of the KTW guideline of the German Federal Environmental Agency (UBA).

Geometric Properties

Bonding and threaded fittings in accordance to DIN EN ISO 1452-3. Also correspond to DIN CERTCO ZP 12.1.10.

Tolerances of z-sizes depending on the dimension. Up to d/D 160 = +/- 3 mm and from d/D 180 = +/- 10 mm.

Bonding-connection

Solvent cement bonding and adaptor fittings are useable for the connection of PVC-U pipes, with outside diameter tolerances in accordance with DIN 8062 respectively ISO 11922-1.

Threaded-connection

The threaded connection of B-R adaptor fittings with reinforcing ring comply with the requirements of DIN EN 10226 respectively ISO 7 [female-thread = cylindrical, male-thread = conical].

The female threaded fittings without reinforcing ring are conical due to ISO 7 specifications.

The sealing of PVC-U threads is to be performed exclusively with PTFE tape.

Hemp and sealing paste are unsuitable and may not be used!

Working pressure

The admissible pressure has to be used according to the respective measure listing. Unless otherwise stated: Target value for bonding fittings: PN16 = 16 bar at 20°C (water).

Target value for adaptor-/threaded-fittings and unions: PN10 = 10 bar at 20°C (water).

Solvent cement

A cement with gap-filling properties on the basis of THF must be used. Our detailed instructions for solvent connections are based on the use of TANGIT solvent cement.

Length of bonding

The tables in the catalogue do not contain these lengths. Those are contained only in the below shown table.

Delivery

Supply only in complete packing units (PU's).

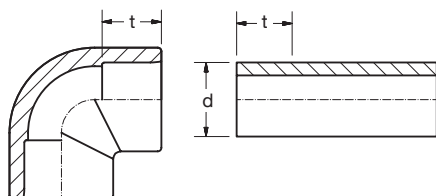

BR PVC-U Muffen-Einstecktiefe

BR- PVC-U socket/pipe length to be entered

d [mm]	t [mm]
10	12
12	12
16	14
20	16
25	19
32	22
40	26
50	31
63	38
75	44
90	51
110	61
140	76
160	86
225	119
250	131
280	146
315	164

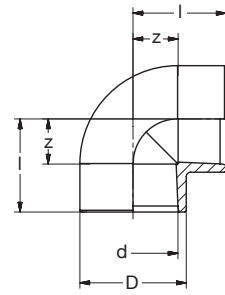
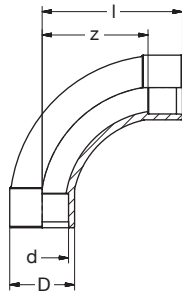

BR PVC-U Bogen 90° grau
BR PVC-U Bend 90° grey

BR PVC-U Winkel 90° grau
BR PVC-U Elbow 90° grey

Art Nr	d	DN	D	l	z	PN	KG	VE1	VE2
Art No	[mm]	[mm]				[bar]		PU1	PU2
1420 0590 12	16	10	23	46	32	16	0,02	10	80
1420 0690 12	20	15	27	56	40	16	0,03	10	80
1420 0790 12	25	20	35	69	50	16	0,05	10	40
1420 0890 12	32	25	40	86	64	16	0,09	5	50
1420 0990 12	40	32	49	106	80	16	0,15	5	30
1420 1090 12	50	40	61	131	100	16	0,27	5	30
1420 1190 12	63	50	76	164	126	16	0,51	2	20
1420 1290 12	75	65	94	190	149	16	1,02	2	8
1420 1390 12	90	80	112	231	180	16	1,79	1	6
1420 1490 12	110	100	137	283	222	16	3,06	1	4
1420 1690 12	140	125	167	355	280	16	5,02	1	2
1420 1790 12	160	150	190	410	319	16	7,41	1	-

Art Nr	d	DN	D	l	z	PN	KG	VE1	VE2
Art No	[mm]	[mm]				[bar]		PU1	PU2
1410 0390 12	10	6	14	18	6	16	0,004	10	300
1410 0490 12	12	8	17	19	7	16	0,005	10	300
1410 0590 12	16	10	23	23	9	16	0,01	10	120
1410 0690 12	20	15	28	27	11	16	0,02	10	120
1410 0790 12	25	20	32	33	14	16	0,03	10	100
1410 0890 12	32	25	40	39	17	16	0,05	10	90
1410 0990 12	40	32	49	49	23	16	0,09	5	50
1410 1090 12	50	40	61	59	27	16	0,16	10	60
1410 1190 12	63	50	75	72	34	16	0,29	5	35
1410 1290 12	75	65	92	82	39	16	0,52	2	24
1410 1390 12	90	80	110	97	46	16	0,70	2	12
1410 1490 12	110	100	132	117	56	16	1,33	2	8
1410 1690 12	140	125	167	147	71	16	2,37	1	4
1410 1790 12	160	150	190	167	81	16	3,73	1	-
1410 2090 32	225	200	256	233	114	10	7,74	1	-
1410 2190 32	250	225	286	317	186	10	9,60	1	-
1410 2290 32	280	250	319	357	210	10	16,4	1	-
1410 2390 32	315	300	360	401	236	10	23,0	1	-

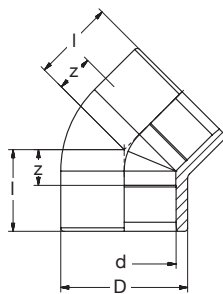

BR PVC-U Winkel 45° grau
BR PVC-U Elbow 45° grey

Art Nr	d	DN	D	l	z	PN	KG	VE1	VE2
Art No	[mm]	[mm]				[bar]		PU1	PU2
1410 0545 12	16	10	23	19	5	16	0,01	10	150
1410 0645 12	20	15	28	21	5	16	0,02	10	160
1410 0745 12	25	20	34	25	6	16	0,03	10	90
1410 0845 12	32	25	41	30	8	16	0,04	10	50
1410 0945 12	40	32	51	36	10	16	0,08	5	30
1410 1045 12	50	40	61	43	12	16	0,12	5	30
1410 1145 12	63	50	77	52	14	16	0,22	5	40
1410 1245 12	75	65	90	60	17	16	0,32	2	12
1410 1345 12	90	80	110	71	20	16	0,64	2	6
1410 1445 12	110	100	132	85	24	16	0,94	2	10
1410 1645 12	140	125	164	105	30	16	1,59	1	-
1410 1745 12	160	150	188	120	34	16	2,47	1	4
1410 2045 12	225	200	259	172	49	10	5,53	1	-
1410 2145 32	250	225	287	190	58	10	7,70	1	-
1410 2245 32	280	250	320	208	62	10	10,4	1	-
1410 2345 32	315	300	360	232	68	10	13,7	1	-

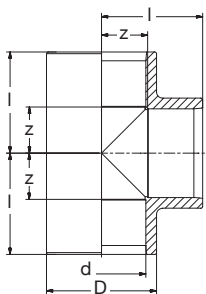

BR PVC-U T-Stück 90° grau

BR PVC-U Tee 90° grey

Art Nr	d	DN	D	l	z	PN	KG	VE1	VE2
Art No	[mm]		[mm]			[bar]		PU1	PU2
1510 0390 32	10	6	16	19	6	16	0,010	10	140
1510 0490 32	12	8	19	20	7	16	0,010	10	100
1510 0590 12	16	10	23	23	9	16	0,016	10	100
1510 0690 12	20	15	28	27	11	16	0,021	10	100
1510 0790 12	25	20	34	33	14	16	0,036	10	60
1510 0890 12	32	25	41	39	17	16	0,061	10	80
1510 0990 12	40	32	49	47	21	16	0,12	5	40
1510 1090 12	50	40	62	58	27	16	0,21	10	40
1510 1190 12	63	50	77	72	34	16	0,38	5	30
1510 1290 12	75	65	92	84	39	16	0,67	2	16
1510 1390 12	90	80	110	97	46	16	0,96	2	8
1510 1490 12	110	100	132	117	56	16	1,70	2	8
1510 1690 12	140	125	170	149	73	16	3,58	1	-
1510 1790 12	160	150	191	169	83	16	4,64	1	-
1510 2090 12	225	200	256	233	114	10	10,1	1	-
1510 2190 32	250	225	286	261	132	10	13,2	1	-
1510 2290 32	280	250	319	290	144	10	18,1	1	-
1510 2390 32	315	300	360	326	162	10	24,4	1	-

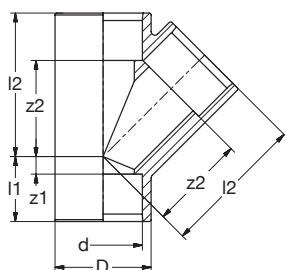

BR PVC-U Abzweiger 45° grau

BR PVC-U Branch 45° grey

Art Nr	d	DN	D	l1	l2	z1	z2	PN	KG	VE1	VE2
Art No	[mm]		[mm]					[bar]		PU1	PU2
1510 0645 32	20	15	28	23	47	5	30	10	0,040	10	-
1510 0745 32	25	20	33	28	56	6	37	10	0,060	10	50
1510 0845 12	32	25	41	29	61	7	39	10	0,086	10	50
1510 0945 12	40	32	51	35	75	9	49	10	0,19	10	30
1510 1045 12	50	40	63	42	92	11	61	10	0,34	5	15
1510 1145 12	63	50	77	52	115	14	77	10	0,51	5	10
1510 1245 12	75	65	90	63	144	19	100	6	0,87	2	10
1510 1345 32	90	80	107	70	175	19	116	6	1,25	1	4
1510 1445 12	110	100	136	88	210	27	148	6	2,81	1	4

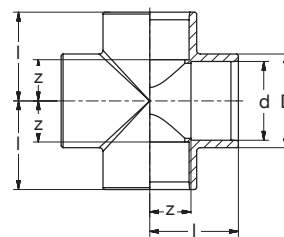

BR PVC-U Kreuz grau

BR PVC-U Cross grey

Art Nr	d	DN	D	l	z	PN	KG	VE1	VE2
Art No	[mm]		[mm]			[bar]		PU1	PU2
1550 0700 32	25	20	34	32	14	16	0,049	10	40
1550 0800 12	32	25	40	39	17	16	0,068	10	50
1550 0900 12	40	32	51	47	21	16	0,15	10	40
1550 1000 12	50	40	63	57	26	16	0,26	10	30
1550 1100 12	63	50	77	72	34	16	0,46	5	15

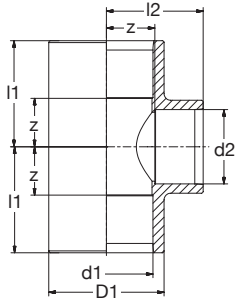

BR PVC-U T-Stück 90° red grau

BR PVC-U Tee 90° red grey

Art Nr	d1-d2	DN1-DN2	D1	l1	l2	z	PN		VE1	VE2
Art No	[mm]		[mm]				[bar]		PU1	PU2
1520 0706 12	25-20	20-15	33	33	30	14	16	0,046	10	60
1520 0806 22	32-20	25-15	41	39	33	17	16	0,072	10	80
1520 0807 22	32-25	25-20	41	39	36	17	16	0,066	10	80
1520 0906 12	40-20	32-15	50	49	39	24	16	0,11	10	40
1520 0907 12	40-25	32-20	50	49	42	24	16	0,11	10	40
1520 0908 22	40-32	32-25	50	49	45	24	16	0,10	10	40
1520 1006 12	50-20	40-15	62	58	48	27	16	0,20	10	40
1520 1007 12	50-25	40-20	62	58	48	27	16	0,20	10	40
1520 1008 12	50-32	40-25	62	58	48	27	16	0,18	10	40
1520 1009 12	50-40	40-32	62	58	58	27	16	0,25	10	40
1520 1106 12	63-20	50-15	75	71	51	33	16	0,29	5	15
1520 1107 12	63-25	50-20	75	71	53	33	16	0,29	5	15
1520 1108 12	63-32	50-25	75	71	56	33	16	0,29	5	15
1520 1109 12	63-40	50-32	75	71	60	33	16	0,29	5	20
1520 1110 12	63-50	50-40	75	71	65	33	16	0,29	5	15
1520 1210 32	75-50	65-40	92	84	72	39	16	0,51	5	-
1520 1211 32	75-63	65-50	92	84	79	39	16	0,56	5	-
1520 1311 32	90-63	80-50	110	97	93	46	16	0,89	1	-
1520 1312 32	90-75	80-65	110	97	99	46	16	0,89	1	-
1520 1413 32	110-90	100-80	132	117	116	56	16	1,50	1	-
1520 1714 32	160-110	150-100	191	169	142	83	16	4,10	1	-
1520 2017 32	225-160	200-150	256	233	205	114	10	10,0	1	-

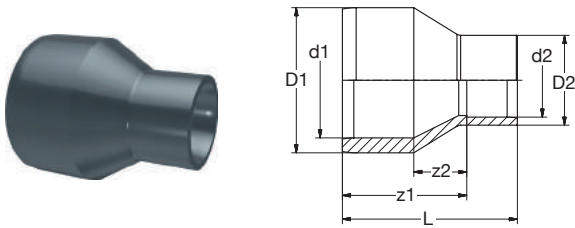

BR PVC-U Reduktion lang grau

BR PVC-U Reducer long grey

Art Nr	d1-d2	d1-d2	d1-D2	D1-D2	DN1	DN2	D2	L	z1	z2	PN	KG	VE1	VE2	
Art No	[mm]	[mm]										[bar]		PU1	PU2
1321 0403 32	12-10	8-10			8	6	13	27	15	3	16	0,004	10	-	
1321 0503 32	16-10	12-10	12-16	16-16	10	6	16	30	18	6	16	0,010	10	-	
1321 0604 32	20-12	16-12	16-16	20-16	15	8	16	33	22	7	16	0,010	10	150	
1321 0605 12	20-16				15	10	22	34	20		16	0,009	10	150	
1321 0704 32	25-12	20-12	20-16	25-16	20	8	16	38	25	10	16	0,010	10	-	
1321 0705 12	25-16				20	10	22	39	25		16	0,011	10	200	
1321 0706 12	25-20				20	15	26	40	24		16	0,012	10	120	
1321 0805 12	32-16	25-16			25	10	22	44	30	11	16	0,016	10	90	
1321 0806 12	32-20	25-20			25	15	26	46	30	11	16	0,017	10	90	
1321 0807 12	32-25				25	20	31	48	30		16	0,021	10	90	
1321 0905 12	40-16	32-16			32	10	22	50	36	14	16	0,025	10	60	
1321 0906 12	40-20	32-20			32	15	26	52	36	14	16	0,029	10	60	
1321 0907 12	40-25	32-25			32	20	31	55	36	14	16	0,029	10	60	
1321 0908 12	40-32				32	25	39	59	37	14	16	0,035	10	60	
1321 1006 12	50-20	40-20			40	15	26	60	44	18	16	0,052	10	50	
1321 1007 12	50-25	40-25			40	20	32	62	44	18	16	0,052	10	50	
1321 1008 12	50-32	40-32			40	25	39	66	44	18	16	0,060	10	40	
1321 1009 12	50-40				40	32	48	70	44		16	0,082	10	30	
1321 1107 12	63-25	50-25			50	20	32	73	54	23	16	0,085	5	40	
1321 1108 12	63-32	50-32			50	25	39	76	54	23	16	0,092	5	40	
1321 1109 12	63-40	50-40			50	32	48	80	54	23	16	0,099	5	40	
1321 1110 12	63-50				50	40	60	85	54		16	0,10	5	40	
1321 1208 32	75-32	63-32	63-40	75-40	65	25	40	85	62	25	16	0,14	5	-	
1321 1209 32	75-40	63-40	63-50	75-50	65	32	50	88	62	24	16	0,15	5	-	
1321 1210 32	75-50	63-50	63-63	75-63	65	40	63	93	62	24	16	0,17	5	-	
1321 1211 32	75-63	63-63			65	50	75	101	62	25	16	0,21	5	-	
1321 1309 32	90-40	75-40	75-50	90-50	80	32	50	101	74	31	16	0,23	5	-	
1321 1310 32	90-50	75-50	75-63	90-63	80	40	63	105	74	30	16	0,24	5	-	
1321 1311 32	90-63	75-63	75-75	90-75	80	50	75	113	74	31	16	0,28	5	-	
1321 1312 32	90-75	75-75			80	65	90	119	74	31	16	0,34	5	-	
1321 1614 32	140-110				125	100	126	172	110		16	0,83	1	-	

D1-d2 Maße = Rohr-Muffe Sizes = Pipe-Socket
d1-d2 Maße = Muffe-Muffe Sizes = Socket-Socket
d1-D2 Maße = Muffe-Rohr Sizes = Socket-Pipe
D1-D2 Maße = Rohr-Rohr Sizes = Pipe-Pipe

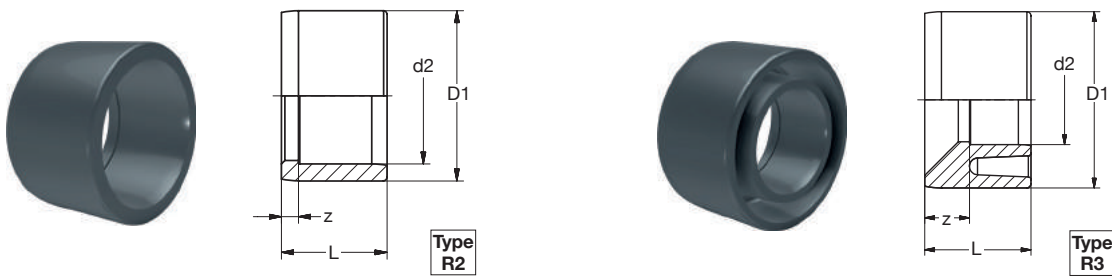

BR PVC-U Reduktion kurz grau
BR PVC-U Reducer short grey

Art Nr Art No	D1-d2 [mm]	DN1-DN2 [mm]	Type		L [mm]	z [mm]	PN [bar]	KG	VE1	VE2
			R2	R3					PU1	PU2
1322 0504 12	16-12	10-8	•		14	2	16	0,002	10	1000
1322 0605 12	20-16	15-10	•		16	2	16	0,003	10	500
1322 0705 12	25-16	20-10	•		19	5	16	0,008	10	300
1322 0706 12	25-20	20-15	•		19	3	16	0,005	10	200
1322 0805 12	32-16	25-10	•		22	8	16	0,014	10	150
1322 0806 12	32-20	25-15	•		22	6	16	0,015	10	140
1322 0807 12	32-25	25-20	•		22	3	16	0,009	10	140
1322 0905 12	40-16	32-10	•		26	12	16	0,021	10	120
1322 0906 12	40-20	32-15	•		26	10	16	0,023	10	120
1322 0907 12	40-25	32-20	•		26	7	16	0,021	10	120
1322 0908 12	40-32	32-25	•		26	4	16	0,016	10	120
1322 1006 12	50-20	40-15	•		31	15	16	0,040	10	80
1322 1007 12	50-25	40-20	•		31	12	16	0,041	10	80
1322 1008 12	50-32	40-25	•		31	9	16	0,039	10	80
1322 1009 12	50-40	40-32	•		31	5	16	0,029	10	80
1322 1107 12	63-25	50-20	•		38	19	16	0,083	10	70
1322 1108 12	63-32	50-25	•		38	16	16	0,077	10	70
1322 1109 12	63-40	50-32	•		38	12	16	0,073	10	70
1322 1110 12	63-50	50-40	•		38	7	16	0,062	10	70
1322 1208 12	75-32	65-25	•		44	21	16	0,11	10	60
1322 1209 12	75-40	65-32	•		44	17	16	0,11	10	60
1322 1210 12	75-50	65-40	•		44	13	16	0,11	10	60
1322 1211 12	75-63	65-50	•		44	7	16	0,085	10	60
1322 1309 12	90-40	80-32	•		51	25	16	0,18	2	40
1322 1310 12	90-50	80-40	•		51	20	16	0,18	2	40
1322 1311 12	90-63	80-50	•		51	13	16	0,18	2	40
1322 1312 12	90-75	80-65	•		51	8	16	0,14	2	40
1322 1410 12	110-50	100-40	•		61	31	16	0,30	2	20
1322 1411 12	110-63	100-50	•		61	24	16	0,31	2	20
1322 1412 12	110-75	100-65	•		61	17	16	0,31	2	18
1322 1413 12	110-90	100-80	•		61	10	16	0,26	2	18
1322 1514 32	125-110	100-100	•		69	8	16	0,26	2	18
1322 1612 12	140-75	125-65	•		76	32	16	0,62	2	20
1322 1613 12	140-90	125-80	•		76	25	16	0,62	2	20
1322 1614 12	140-110	125-100	•		76	15	16	0,60	2	20
1322 1615 32	140-125	125-100	•		76	7	16	0,33	2	20
1322 1713 12	160-90	150-80	•		86	34	16	0,84	2	6
1322 1714 12	160-110	150-100	•		86	24	16	0,86	2	6
1322 1716 12	160-140	150-125	•		86	10	16	0,57	2	6
1322 1917 32	200-160	180-150	•		106	20	10	1,67	1	3
1322 2017 12	225-160	200-150	•		119	33	10	2,19	1	3
1322 2019 32	225-200	200-180	•		119	33	10	1,70	1	-
1322 2120 32	250-225	225-200	•		132	12	10	4,44	1	-
1322 2220 32	280-225	250-200	•		146	27	10	4,70	1	-
1322 2221 32	280-250	250-225	•		146	15	10	5,68	1	-
1322 2320 32	315-225	300-200	•		163	45	10	6,52	1	-
1322 2321 32	315-250	300-225	•		164	33	10	6,49	1	-
1322 2322 32	315-280	300-250	•		163	17	10	6,70	1	-

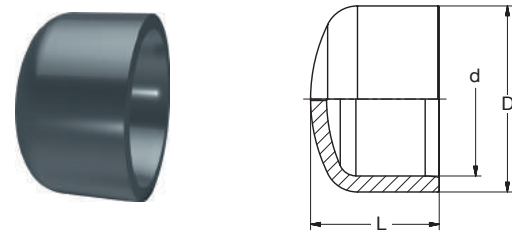
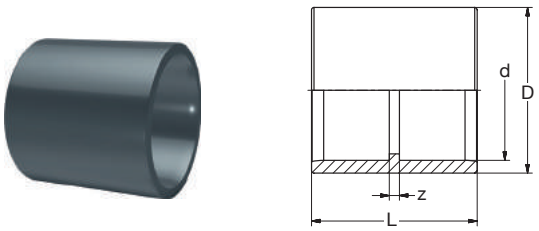

BR PVC-U Muffe grau
BR PVC-U Socket grey

Art Nr	d	DN	D	L	z	PN	KG	VE1	VE2
Art No	[mm]		[mm]			[bar]		PU1	PU2
1310 0200 32	8	5	14	28	3	16	0,004	A	-
1310 0300 32	10	6	16	28	3	16	0,010	10	-
1310 0400 32	12	8	19	28	3	16	0,010	10	-
1310 0500 12	16	10	22	32	3	16	0,008	10	200
1310 0600 12	20	15	26	34	3	16	0,011	10	200
1310 0700 12	25	20	31	40	3	16	0,015	10	140
1310 0800 12	32	25	39	47	3	16	0,022	10	70
1310 0900 12	40	32	48	56	4	16	0,037	10	80
1310 1000 12	50	40	60	66	4	16	0,070	10	60
1310 1100 12	63	50	75	80	4	16	0,14	5	30
1310 1200 12	75	65	89	96	8	16	0,54	2	20
1310 1300 12	90	80	107	108	4	16	0,38	2	12
1310 1400 12	110	100	130	130	8	16	0,63	2	18
1310 1600 12	140	125	163	160	8	16	1,21	1	8
1310 1700 12	160	150	186	182	8	16	1,81	1	2
1310 2000 12	225	200	260	248	12	10	3,41	1	-
1310 2100 32	250	225	287	282	14	10	5,70	1	-
1310 2200 32	280	250	320	314	18	10	7,30	1	-
1310 2300 32	315	300	355	348	14	10	9,20	1	-

BR PVC-U Kappe grau
BR PVC-U Cap grey

Art Nr	d	DN	D	L	PN	KG	VE1	VE2
Art No	[mm]		[mm]		[bar]		PU1	PU2
1340 0400 32	12	8	21	16	16	0,008	10	-
1340 0500 12	16	10	23	20	16	0,006	10	250
1340 0600 12	20	15	28	23	16	0,009	10	200
1340 0700 12	25	20	34	26	16	0,014	10	120
1340 0800 12	32	25	41	32	16	0,023	10	120
1340 0900 12	40	32	52	39	16	0,046	10	80
1340 1000 12	50	40	63	48	16	0,077	10	70
1340 1100 12	63	50	77	56	16	0,12	5	120
1340 1200 12	75	65	90	66	10	0,19	2	16
1340 1300 12	90	80	110	77	10	0,34	2	16
1340 1400 12	110	100	133	92	6	0,62	2	8
1340 1600 12	140	125	161	121	6	0,94	1	5
1340 1700 12	160	150	185	136	4	1,48	1	8
1340 2000 12	225	200	260	174	4	3,44	1	2

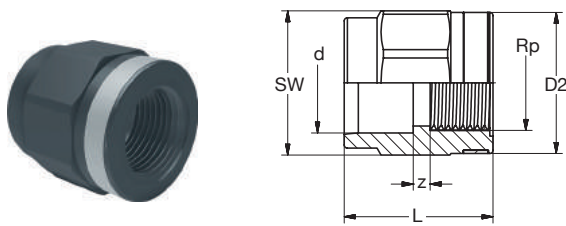

BR PVC-U Übergang IG-zyl grau
BR PVC-U Transition female-thread-cyl grey

Art Nr Art No	d x Rp [mm x Inch]	DN	D2	L	z	SW	PN [bar]	KG	VE1 PU1	VE2 PU2
161M 0441 32	12 x 1/4	8	20	27	4	22	10	0,010	10	-
161M 0542 12	16 x 3/8	10	25	30	5	27	10	0,016	10	150
161M 0643 12	20 x 1/2	15	30	36	5	30	10	0,025	10	150
161M 0745 12	25 x 3/4	20	35	40	5	36	10	0,032	10	100
161M 0846 12	32 x 1	25	45	47	5	46	10	0,056	10	60
161M 0947 12	40 x 1 1/4	32	55	52	5	55	10	0,090	10	80
161M 1048 12	50 x 1 1/2	40	65	60	7	65	10	0,15	10	60
161M 1150 12	63 x 2	50	75	72	7	80	10	0,22	5	75
161M 1253 22	75 x 2 1/2	65	89	92	18	90	10	0,31	5	-
161M 1355 22	90 x 3	80	107	107	23	108	10	0,52	5	-
161M 1457 32	110 x 4	100	130	128	28	131	10	0,74	5	-

Anschluss an Metall- oder Kunststoffgewinde.
Connection to metal or plastic thread.

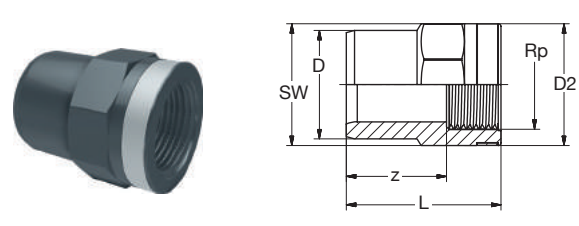

BR PVC-U Ü-Reduktion IG-zyl grau
BR PVC-U Transition-Reducer female-thread-cyl grey

Art Nr Art No	D x Rp [mm x Inch]	DN	D2	L	z	SW	PN [bar]	KG	VE1 PU1	VE2 PU2
163M 0441 32	12 x 1/4	8	20	27	17	22	10	0,010	10	-
163M 0642 12	20 x 3/8	15	25	35	24	27	10	0,016	10	150
163M 0743 12	25 x 1/2	20	30	42	27	32	10	0,025	10	150
163M 0845 12	32 x 3/4	25	35	48	32	36	10	0,037	10	80
163M 0946 12	40 x 1	32	45	56	36	46	10	0,069	10	50
163M 1047 12	50 x 1 1/4	40	55	66	46	55	10	0,12	10	60
163M 1148 12	63 x 1 1/2	50	65	77	55	65	5	0,18	5	40

Anschluss an Metall- oder Kunststoffgewinde.
Connection to metal or plastic thread.

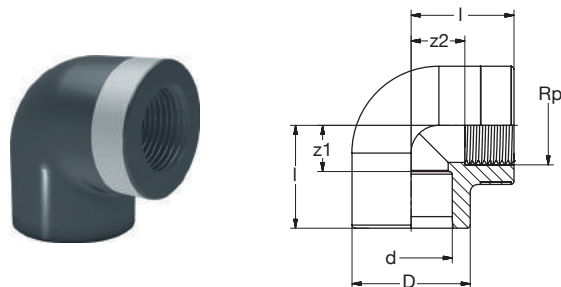

BR PVC-U Ü-Winkel 90° IG-zyl grau
BR PVC-U Transition-Elbow 90° female-thread-cyl grey

Art Nr Art No	d x Rp [mm x Inch]	DN	D	l	z1	z2	PN [bar]	KG	VE1 PU1	VE2 PU2
162M 0441 32	12 x 1/4	8	20	19	7	8	10	0,010	10	-
162M 0542 32	16 x 3/8	10	25	23	9	12	10	0,020	10	-
162M 0643 12	20 x 1/2	15	30	28	12	14	10	0,033	10	120
162M 0745 12	25 x 3/4	20	36	34	14	17	10	0,050	10	60
162M 0846 12	32 x 1	25	47	40	17	22	10	0,096	10	30
162M 0947 12	40 x 1 1/4	32	55	49	22	28	10	0,17	10	90
162M 1048 12	50 x 1 1/2	40	65	59	27	38	10	0,27	10	20
162M 1150 32	63 x 2	50	75	71	33	46	10	0,29	5	-

Anschluss an Metall- oder Kunststoffgewinde.
Connection to metal or plastic thread.

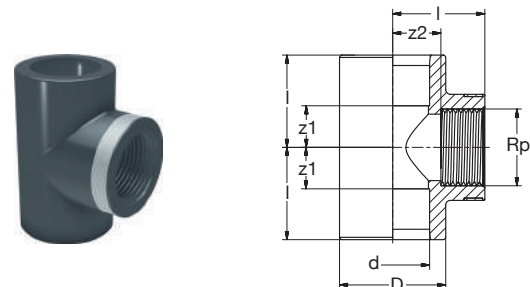

BR PVC-U Ü-T-Stück 90° IG-zyl grau
BR PVC-U Transition-Tee 90° female-thread-cyl grey

Art Nr Art No	Füßhöhe d x Rp [mm x Inch]	DN	D	l	z1	z2	PN [bar]	KG	VE1 PU1	VE2 PU2
164M 0441 32	12 x 1/4	8	20	19	7	8	10	0,020	10	-
164M 0542 32	16 x 3/8	10	25	23	9	12	10	0,030	10	-
164M 0643 12	20 x 1/2	15	30	28	12	14	10	0,040	10	80
164M 0745 12	25 x 3/4	20	36	33	14	17	10	0,062	10	50
164M 0846 12	32 x 1	25	47	40	18	22	10	0,13	10	20
164M 0947 12	40 x 1 1/4	32	55	49	22	28	10	0,21	10	30
164M 1048 12	50 x 1 1/2	40	65	59	27	38	10	0,31	10	20
164M 1150 32	63 x 2	50	75	71	33	46	10	0,41	5	-

Anschluss an Metall- oder Kunststoffgewinde.
Connection to metal or plastic thread.

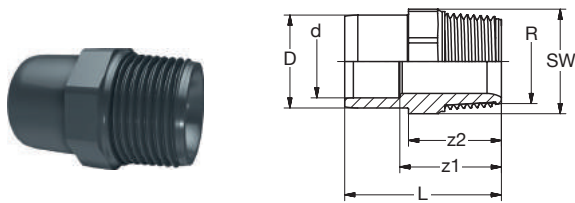

BR PVC-U Ü-Reduktion/Muffe **AG-keg** grau

BR PVC-U Transition-Reducer/Socket male-thread-con grey

Art Nr	D / d x R	DN / DN	L	z1	z2	SW	PN	KG	VE1	VE2
Art No	[mm x Inch]		[mm]				[bar]		PU1	PU2
1610 0572 12	16 / 12 x 3/8	10 / 8	35	23	21	22	10	0,010	10	150
1610 0672 12	20 / 16 x 3/8	15 / 10	37	23	21	27	10	0,010	10	150
1610 0673 12	20 / 16 x 1/2	15 / 10	42	28	26	24	10	0,012	10	160
1610 0773 12	25 / 20 x 1/2	20 / 15	45	29	26	30	10	0,017	10	130
1610 0775 12	25 / 20 x 3/4	20 / 15	47	31	28	30	10	0,019	10	100
1610 0875 12	32 / 25 x 3/4	25 / 20	50	31	28	36	10	0,028	10	100
1610 0876 12	32 / 25 x 1	25 / 20	54	35	32	36	10	0,031	10	50
1610 0976 12	40 / 32 x 1	32 / 25	58	36	32	46	10	0,044	10	60
1610 0977 12	40 / 32 x 1 1/4	32 / 25	60	38	34	46	10	0,049	10	100
1610 1077 12	50 / 40 x 1 1/4	40 / 32	65	39	34	55	10	0,069	10	60
1610 1078 12	50 / 40 x 1 1/2	40 / 32	65	41	35	55	10	0,075	10	70
1610 1178 12	63 / 50 x 1 1/2	50 / 40	73	42	35	65	10	0,12	5	60
1610 1180 12	63 / 50 x 2	50 / 40	78	47	40	65	10	0,14	5	60
1610 1280 12	75 / 63 x 2	65 / 50	84	46	40	80	10	0,17	5	60

Anschluss an Kunststoffgewinde.
Connection to plastic thread.

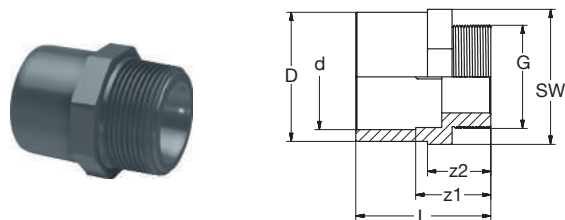

BR PVC-U Ü-Reduktion/Muffe **AG-zyl** grau

BR PVC-U Transition-Reducer/Socket male-thread-cyl grey

Art Nr	D / d x G	DN / DN	L	z1	z2	SW	PN	KG	VE1	VE2
Art No	[mm x Inch]		[mm]				[bar]		PU1	PU2
1610 1383 32	90 / 75 x 2 1/2	80 / 65	99	55	48	95	10	0,31	2	32
1610 1485 32	110 / 90 x 3	100 / 80	113	62	52	115	10	0,44	2	18
1610 1587 32	125 / 110 x 4	100 / 100	120	59	54	130	10	0,71	1	12

Anschluss an Kunststoffgewinde.
Connection to plastic thread.

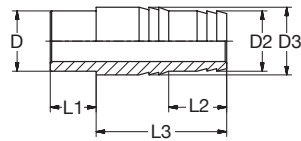

BR PVC-U Druckschlauchtülle grau

BR PVC-U Hose nozzle grey

Art Nr	D	D2	D3	L1	L2	L3	PN	KG	VE1	VE2
Art No	[mm]			[mm]			[bar]		PU1	PU2
1380 0300 12	10	10	-	12	-	39	10	0,002	10	3000
1380 0400 12	12	12	-	12	-	39	10	0,004	10	1800
1380 0500 32	16	16	18	14	18	40	10	0,010	10	1000
1380 0600 32	20	20	22	16	20	44	10	0,015	10	600
1380 0700 32	25	25	28	19	24	54	10	0,020	10	450
1380 0800 32	32	31	34	22	28	63	10	0,044	10	250
1380 0900 32	40	40	43	26	32	72	10	0,060	10	200
1380 1000 32	50	50	53	31	35	80	10	0,11	10	120
1380 1100 32	63	60	66	38	40	90	10	0,15	10	60

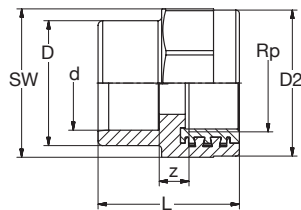

BR PVC-U-RG Übergang IG-zyl grau

BR PVC-U-Bronze Transition female-thread-cyl grey

Art Nr	d x Rp	DN	D	D2	L	z	SW	PN	KG	VE1	VE2
Art No	[mm x Inch]				[mm]			[bar]		PU1	PU2
1R10 0643 12	20 x 1/2	15	29	35	40	10	36	16	0,076	10	100
1R10 0745 12	25 x 3/4	20	34	43	42	8	44	16	0,12	10	50
1R10 0846 12	32 x 1	25	43	50	52	12	51	16	0,18	10	50
1R10 0947 12	40 x 1 1/4	32	52	62	59	13	63	16	0,26	10	36
1R10 1048 12	50 x 1 1/2	40	64	69	65	14	70	16	0,30	2	24
1R10 1150 12	63 x 2	50	79	84	78	19	85	16	0,57	2	12

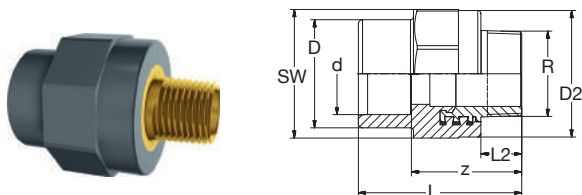

BR PVC-U-RG Übergang AG-keg grau

BR PVC-U-Bronze Transition male-thread-con grey

Art Nr	d x R	DN	D	D2	L	L2	z	SW	PN	KG	VE1	VE2
Art No	[mm x Inch]	[mm]							[bar]		PU1	PU2
1R10 0673 12	20 x 1/2	15	29	35	55	13	39	36	16	0,10	10	90
1R10 0775 12	25 x 3/4	20	34	43	58	14	39	44	16	0,14	10	50
1R10 0876 12	32 x 1	25	43	50	70	16	48	51	16	0,23	10	40
1R10 0977 12	40 x 1 1/4	32	52	62	79	20	53	63	16	0,36	2	24
1R10 1078 12	50 x 1 1/2	40	64	69	85	20	54	70	16	0,42	2	16
1R10 1180 12	63 x 2	50	79	84	103	23	65	85	16	0,73	2	12

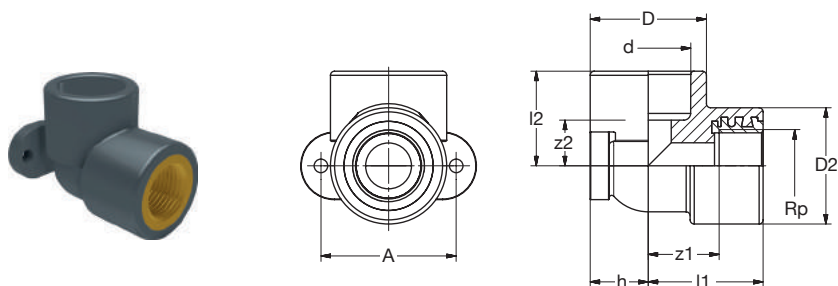

BR PVC-U-RG Ü-Winkel 90° IG-zyl Wandbefestigung grau

BR PVC-U-Bronze Transition-Elbow 90° female-thread-cyl wall-mount grey

Art Nr	d x Rp	DN	D	D2	L1	L2	h	A*	z1	z2	PN	KG	VE1	VE2	
Art No	[mm x Inch]	[mm]										[bar]		PU1	PU2
1R30 0643 12	20 x 1/2	15	29	35	35	27	15	40	21	11	16	0,12	1	50	
1R30 0745 12	25 x 3/4	20	43	43	43	35	22	50	28	19	16	0,18	1	30	

* Abstand der Befestigungslöcher • Distance of mounting holes.

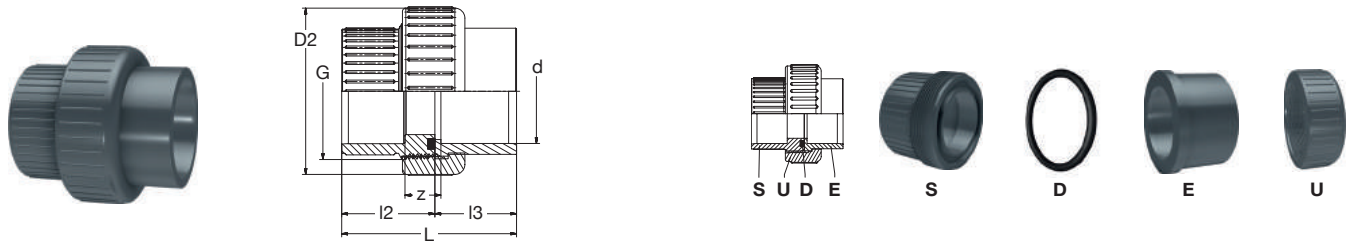

BR PVC-U/EPDM Verschraubung grau
BR PVC-U/EPDM Union grey

Art Nr Art No	d [mm]	DN [mm]	G [Inch]	D2	L	l2	l3	z	PN [bar]	KG	VE1 PU1	VE2 PU2
1350 0300 32	10	6	5/8	31	37	15	22	13	10	0,020	10	-
1350 0400 32	12	8	5/8	31	37	15	22	13	10	0,020	10	-
1350 0500 12	16	10	3/4	35	41	17	24	13	10	0,024	10	140
1350 0600 12	20	15	1	43	46	19	26	13	10	0,039	10	80
1350 0700 12	25	20	1 1/4	53	52	22	30	13	10	0,064	10	90
1350 0800 12	32	25	1 1/2	60	57	25	32	13	10	0,085	10	60
1350 0900 12	40	32	2	74	68	30	38	15	10	0,15	10	40
1350 1000 12	50	40	2 1/4	83	79	35	44	17	10	0,20	10	60
1350 1100 12	63	50	2 3/4	103	97	41	55	21	10	0,35	2	30
1350 1200 12	75	65	3 1/2	122	108	47	61	20	10	0,58	2	18
1350 1300 12	90	80	4	139	124	56	68	22	6	0,75	1	18
1350 1400 12	110	100	5	164	138	66	72	16	6	1,15	1	8

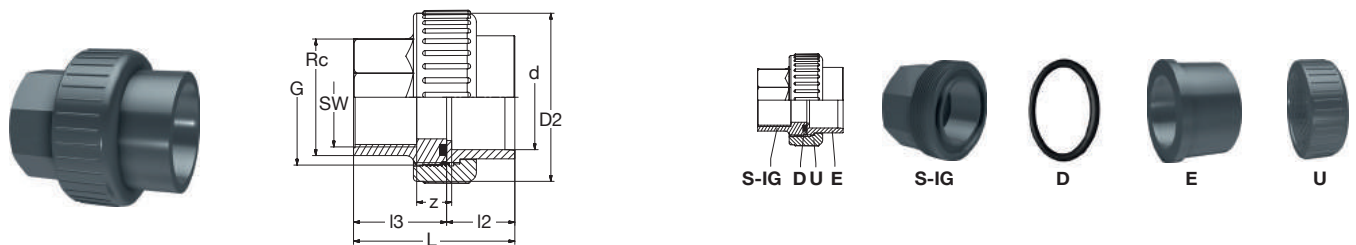

BR PVC-U/EPDM Ü-Verschraubung IG-keg grau
BR PVC-U/EPDM Transition-Union female-thread-con grey

Art Nr Art No	d x Rc [mm x Inch]	DN [mm]	G [Zoll/Inch]	D2	L	l2	l3	z	SW	PN [bar]	KG	VE1 PU1	VE2 PU2
1650 0542 12	16 x 3/8	10	3/4	35	41	17	24	16	22	10	0,024	1	-
1650 0643 12	20 x 1/2	15	1	43	45	19	26	16	27	10	0,039	1	-
1650 0745 12	25 x 3/4	20	1 1/4	53	51	22	29	16	36	10	0,064	1	-
1650 0846 12	32 x 1	25	1 1/2	60	57	25	32	16	41	10	0,085	1	-
1650 0947 12	40 x 1 1/4	32	2	74	67	29	38	20	50	10	0,15	1	-
1650 1048 12	50 x 1 1/2	40	2 1/4	83	79	34	45	27	60	10	0,20	1	-
1650 1150 12	63 x 2	50	2 3/4	103	97	41	56	34	70	10	0,35	1	-

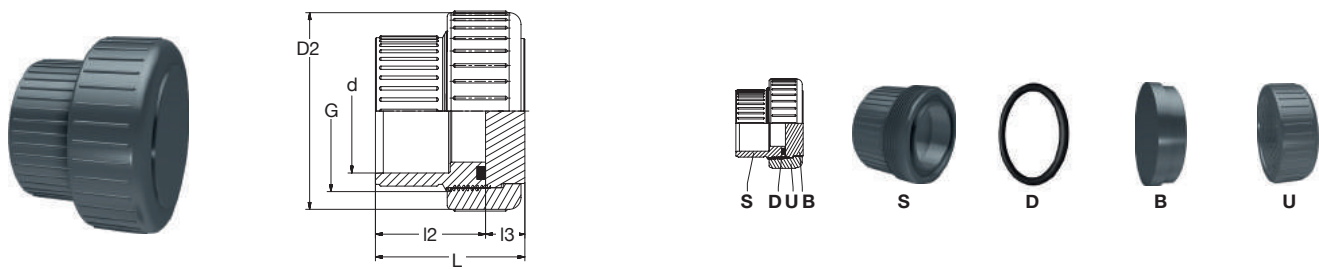

BR PVC-U/EPDM Verschraubung mit Blindteil grau
BR PVC-U/EPDM Union with blind-part grey

Art Nr	d	DN	D2	G	L	l2	l3	PN	KG	VE1	VE2
Art No	[mm]	[mm]	[mm]	[Inch]	[mm]	[mm]	[mm]	[bar]		PU1	PU2
135B 0600 12	20	15	43	1	38	12	26	10	0,038	1	-
135B 0700 12	25	20	53	1 1/4	45	15	30	10	0,068	1	-
135B 0800 12	32	25	60	1 1/2	47	15	32	10	0,097	1	-
135B 0900 12	40	32	74	2	55	17	38	10	0,16	1	-
135B 1000 12	50	40	83	2 1/4	61	17	44	10	0,22	1	-
135B 1100 12	63	50	103	2 1/2	75	20	55	10	0,39	1	-

Ersatzteile Verschraubungen • Spare parts Unions

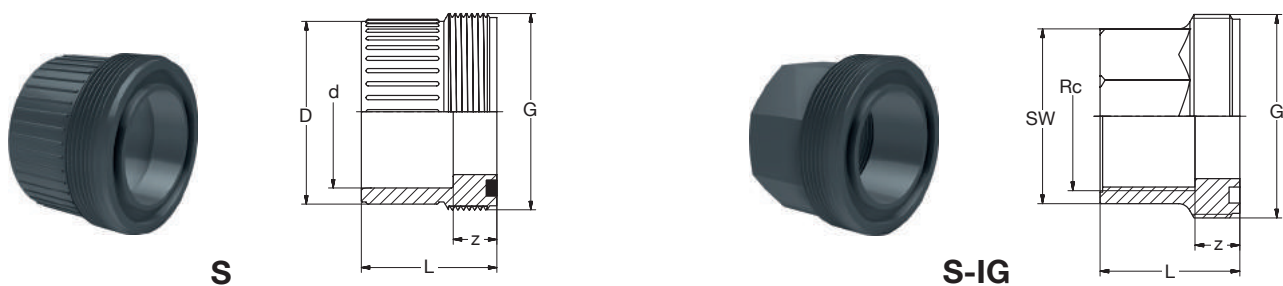

BR PVC-U Verschraubung Schraubteil grau
BR PVC-U Union Screw-part grey

Art Nr	d	DN	G	D	L	z	PN	KG	VE1	VE2
Art No	[mm]	[mm]	[Inch]	[mm]	[mm]	[mm]	[bar]		PU1	PU2
1350 03S0 32	10	6	5/8	20	23	10	10	0,010	10	-
1350 04S0 32	12	8	5/8	20	23	10	10	0,010	10	-
1350 05S0 12	16	10	3/4	23	24	10	10	0,008	50	1500
1350 06S0 12	20	15	1	28	26	10	10	0,013	50	1000
1350 07S0 12	25	20	1 1/4	33	29	10	10	0,020	50	650
1350 08S0 12	32	25	1 1/2	40	31	10	10	0,027	50	400
1350 09S0 12	40	32	2	50	38	12	10	0,032	25	200
1350 10S0 12	50	40	2 1/4	61	44	14	10	0,062	1	180
1350 11S0 12	63	50	2 3/4	76	55	18	10	0,12	1	80
1350 12S0 12	75	65	3 1/2	96	61	17	10	0,22	1	50
1350 13S0 12	90	80	4	109	68	17	6	0,27	1	40
1350 14S0 12	110	100	5	133	72	11	6	0,41	1	30

BR PVC-U Verschraubung Schraubteil IG-keg grau
BR PVC-U Union Screw-part female-thread-con grey

Art Nr	Rc	G	L	z	SW	PN	KG	VE1	VE2
Art No	[Inch]	[Inch]	[mm]	[mm]	[mm]	[bar]		PU1	PU2
1650 42S0 12	3/8	3/4	24	10	22	10	0,009	1	250
1650 43S0 12	1/2	1	26	10	27	10	0,013	1	1000
1650 45S0 12	3/4	1 1/4	29	10	36	10	0,026	1	600
1650 46S0 12	1	1 1/2	32	10	41	10	0,031	1	200
1650 47S0 12	1 1/4	2	38	10	50	10	0,059	1	200
1650 48S0 12	1 1/2	2 1/4	45	10	60	10	0,089	1	150
1650 50S0 12	2	2 3/4	56	12	70	10	0,15	1	90

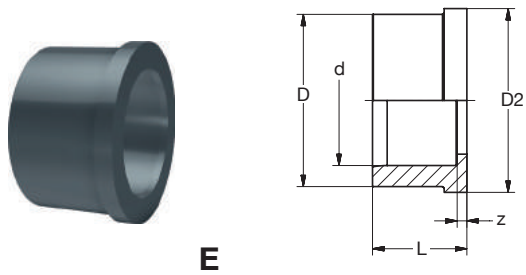

E

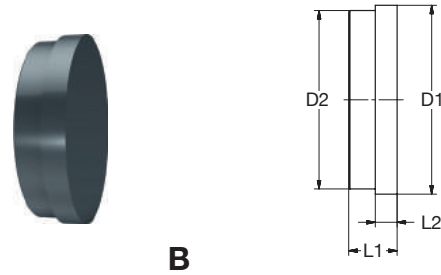

B

BR PVC-U Verschraubung Einleitteil grau
BR PVC-U Union Insert-part grey

Art Nr Art No	d [mm]	DN	D	D2	L	z	PN [bar]	KG	VE1 PU1	VE2 PU2
1350 03E0 32	10	6	19,0	20,0	15	3	10	0,004	10	-
1350 04E0 32	12	8	19,0	20,0	15	3	10	0,004	10	-
1350 05E0 12	16	10	22,0	24,0	17	3	10	0,005	50	1200
1350 06E0 12	20	15	27,5	30,1	19	3	10	0,008	50	700
1350 07E0 12	25	20	36,0	38,8	22	3	10	0,015	50	400
1350 08E0 12	32	25	41,5	44,7	25	3	10	0,020	50	500
1350 09E0 12	40	32	53,0	56,5	29	3	10	0,032	25	300
1350 10E0 12	50	40	59,0	62,6	34	3	10	0,040	1	250
1350 11E0 12	63	50	74,0	78,4	41	3	10	0,073	1	130
1350 12E0 12	75	65	92,5	97,2	47	3	10	0,16	1	70
1350 13E0 12	90	80	105,0	110,0	56	5	6	0,19	1	50
1350 14E0 12	110	100	129,0	134,4	66	5	6	0,34	1	30

BR PVC-U Verschraubung Blindteil grau
BR PVC-U Union Blind-part grey

Art Nr Art No	d [mm]	DN	D1	D2	L1	L2	PN [bar]	KG	VE1 PU1	VE2 PU2
1350 06B0 02	20	15	30,0	27,5	12	5,5	10	0,010	1	-
1350 07B0 02	25	20	39,0	36,0	15	7,0	10	0,017	1	-
1350 08B0 02	32	25	44,3	41,2	15	6,8	10	0,025	1	-
1350 09B0 02	40	32	56,0	53,0	17	8,0	10	0,043	1	-
1350 10B0 02	50	40	62,5	59,0	17	7,0	10	0,062	1	-
1350 11B0 02	63	50	78,0	73,7	20	9,0	10	0,11	1	-

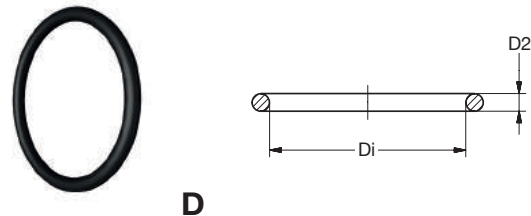

D

Runddichtring-EPDM für Verschraubungen schwarz
O-Ring gasket-EPDM for unions black

Art Nr Art No	G [Inch]	Di [mm]	D2	KG	VE1 PU1
9205 44R1 35	5/8	12,37	2,62	0,001	1
9205 45R1 35	3/4	15,55	2,62	0,001	1
9205 46R1 35	1	20,22	3,53	0,001	1
9201 07R1 35	1 1/4	28,10	3,53	0,002	1
9205 48R1 35	1 1/2	32,92	3,53	0,002	1
9205 50R1 35	2	40,64	5,33	0,003	1
9205 51R1 35	2 1/4	47,00	5,33	0,004	1
9205 54R1 35	2 3/4	59,70	5,33	0,005	1
9205 56R1 35	3 1/2	75,56	5,33	0,01	1
9205 57R1 35	4	91,45	5,33	0,01	1
9205 58R1 35	5	113,66	5,33	0,01	1

Für Wasser, Shorehärte 70
For water, shore hardness 70

Runddichtring-FKM für Verschraubungen schwarz
O-Ring gasket-FKM for unions black

Art Nr Art No	G [Inch]	Di [mm]	D2	KG	VE1 PU1
9205 44R3 35	5/8	12,37	2,62	0,001	1
9205 45R3 35	3/4	15,55	2,62	0,001	1
9205 46R3 35	1	20,22	3,53	0,001	1
9201 07R3 35	1 1/4	28,10	3,53	0,002	1
9205 48R3 35	1 1/2	32,92	3,53	0,002	1
9205 50R3 35	2	40,64	5,33	0,003	1
9205 51R3 35	2 1/4	47,00	5,33	0,004	1
9205 54R3 35	2 3/4	59,70	5,33	0,005	1
9205 56R3 35	3 1/2	75,56	5,33	0,01	1
9205 57R3 35	4	91,45	5,33	0,01	1
9205 58R3 35	5	113,66	5,33	0,01	1

Für Wasser, Shorehärte 70
For water, shore hardness 70

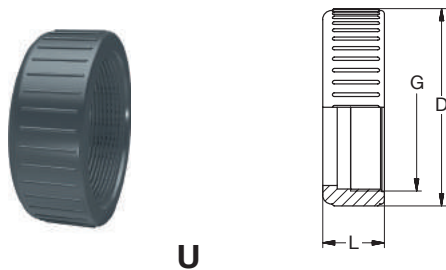

U

BR PVC-U Verschraubung Überwurfmutter IG-zyl grau
BR PVC-U Union Nut female-thread-cyl grey

Art Nr Art No	d [mm]	DN [mm]	G [Inch]	D	L	PN [bar]	KG	VE1 PU1	VE2 PU2
1350 03U0 32	10	6	5/8	29	19	10	0,010	1	-
1350 03U0 32	12	8	5/8	29	19	10	0,010	1	-
1350 05U0 12	16	10	3/4	33	22	10	0,011	50	1000
1350 06U0 12	20	15	1	41	23	10	0,017	50	750
1350 07U0 12	25	20	1 1/4	51	25	10	0,028	50	400
1350 08U0 12	32	25	1 1/2	58	27	10	0,037	25	300
1350 09U0 12	40	32	2	72	30	10	0,061	1	200
1350 10U0 12	50	40	2 1/4	80	34	10	0,087	1	160
1350 11U0 12	63	50	2 3/4	100	38	10	0,15	1	80
1350 12U0 12	75	65	3 1/2	118	43	10	0,21	1	50
1350 13U0 12	90	80	4	134	45	6	0,29	1	40
1350 14U0 12	110	100	5	159	51	6	0,40	1	25

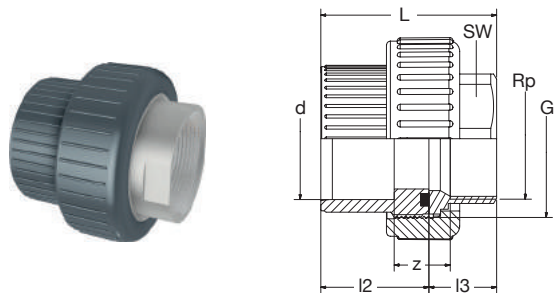

BR PVC-U-GJMW/EPDM Ü-Verschraubung IG-zyl grau

BR PVC-U-GJMW/EPDM Transition-Union female-thread-cyl grey

Art Nr Art No	d x Rp [mm x Inch]	DN [mm]	G [Inch]	L	l2	l3	z	SW	PN [bar]	KG	VE1 PU1
1T50 0542 32	16 x 3/8	10	3/4	43	17	23	19	22	10	0,080	1
1T50 0643 32	20 x 1/2	15	1	47	19	25	19	25	10	0,12	1
1T50 0745 32	25 x 3/4	20	1 1/4	53	22	28	19	31	10	0,26	1
1T50 0846 32	32 x 1	25	1 1/2	59	25	31	20	38	10	0,30	1
1T50 0947 32	40 x 1 1/4	32	2	65	29	33	20	47	10	0,48	1
1T50 1048 32	50 x 1 1/2	40	2 1/4	73	34	36	23	53	10	0,59	1
1T50 1150 32	63 x 2	50	2 3/4	86	41	42	24	66	10	0,80	1
1T50 1253 32	75 x 2 1/2	65	3 1/2	96	47	46	25	83	10	1,29	1
1T50 1355 32	90 x 3	80	4	111	56	52	30	96	10	1,73	1

Anschluss für Metallgewinde, keine Lagerware, nur komplett lieferbar.
Connection for metal thread, no stock item, only available completely.

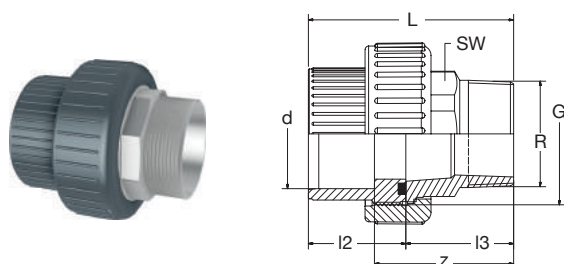

BR PVC-U-GJMW/EPDM Ü-Verschraubung AG-keg grau

BR PVC-U-GJMW/EPDM Transition-Union male-thread-con grey

Art Nr Art No	d x R [mm x Inch]	DN [mm]	G [Inch]	L	l2	l3	z	SW	PN [bar]	KG	VE1 PU1
1T50 0572 32	16 x 3/8	10	3/4	56	17	39	45	21	10	0,090	1
1T50 0673 32	20 x 1/2	15	1	62	19	43	49	25	10	0,18	1
1T50 0775 32	25 x 3/4	20	1 1/4	71	22	49	55	31	10	0,27	1
1T50 0876 32	32 x 1	25	1 1/2	78	25	53	59	38	10	0,34	1
1T50 0977 32	40 x 1 1/4	32	2	87	29	58	65	47	10	0,59	1
1T50 1078 32	50 x 1 1/2	40	2 1/4	96	34	62	68	53	10	0,72	1
1T50 1180 32	63 x 2	50	2 3/4	112	41	71	76	66	10	1,05	1

Anschluss für Metallgewinde, keine Lagerware, nur komplett lieferbar.
Connection for metal thread, no stock item, only available completely.

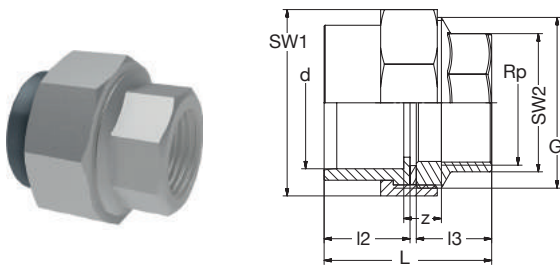

BR PVC-U-V2A/EPDM Ü-Verschraubung IG-zyl grau
BR PVC-U-Stainless Steel/EPDM Transition-Union female-thread cyl grey

Art Nr Art No	d x Rp [mm x Inch]	DN [mm]	G [Inch]	L	l2	l3	z	SW1	SW2	PN [bar]	KG	VE1 PU1
1V50 0643 12	20 x 1/2	15	1	47	19	25	18	38	27	10	0,13	1
1V50 0745 12	25 x 3/4	20	1 1/4	53	22	28	19	47	32	10	0,23	1
1V50 0846 12	32 x 1	25	1 1/2	59	25	31	20	52	38	10	0,30	1
1V50 0947 12	40 x 1 1/4	32	2	65	29	33	20	66	47	10	0,48	1
1V50 1048 12	50 x 1 1/2	40	2 1/4	73	34	36	23	72	53	10	0,59	1
1V50 1150 12	63 x 2	50	2 3/4	86	41	42	24	87	65	10	0,97	1
1V50 1253 12	75 x 2 1/2	65	3 1/2	96	47	46	25	110	82	10	1,60	1
1V50 1355 12	90 x 3	80	4	111	56	52	30	120	95	10	2,09	1
1V50 1457 12	110 x 4	100	5	129	66	60	32	150	123	10	3,39	1

Anschluss für Metallgewinde.
Connection for metal thread.
V2A = 1.4305

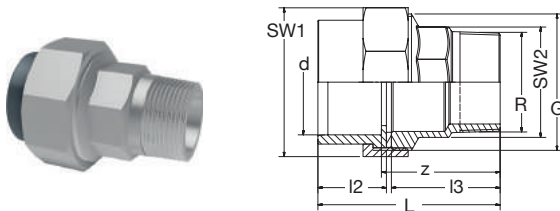

BR PVC-U-V2A Ü-Verschraubung AG-keg grau
BR PVC-U-Stainless Steel/EPDM Transition-Union male-thread cyl grey

Art Nr Art No	d x R [mm x Inch]	DN [mm]	G [Inch]	L	l2	l3	z	SW1	SW2	PN [bar]	KG	VE1 PU1
1V50 0673 12	20 x 1/2	15	1	65	19	43	49	38	27	10	0,16	1
1V50 0775 12	25 x 3/4	20	1 1/4	74	22	49	55	47	27	10	0,26	1
1V50 0876 12	32 x 1	25	1 1/2	81	25	53	59	52	34	10	0,36	1
1V50 0977 12	40 x 1 1/4	32	2	90	29	58	64	66	43	10	0,58	1
1V50 1078 12	50 x 1 1/2	40	2 1/4	99	34	62	68	72	50	10	0,72	1
1V50 1180 12	63 x 2	50	2 3/4	115	41	71	77	87	61	10	1,10	1
1V50 1283 12	75 x 2 1/2	65	3 1/2	128	47	78	84	110	80	10	1,91	1
1V50 1385 12	90 x 3	80	4	146	56	87	95	120	80	10	2,43	1
1V50 1487 12	110 x 4	100	5	169	66	100	102	150	123	10	4,26	1

Anschluss für Metallgewinde.
Connection for metal thread.
V2A = 1.4305

Einlegeteil und Runddichttring als Ersatzteil erhältlich. Siehe PVC Kunststoff Verschraubung.
Insert-part and O-Ring as spare parts available. See PVC Union.

Bundbuchse (BB) in verschiedenen Ausführungen für den Einsatz von Flach- und Runddichtungen.

Weitere Informationen zu Flanschen und Dichtungen finden Sie unter Zubehör.



Flange adaptor socket (BB) in various designs for the use of flat and O-ring gaskets.

More information about flanges and gaskets see Accessories.

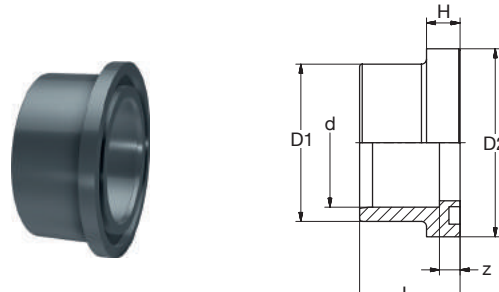
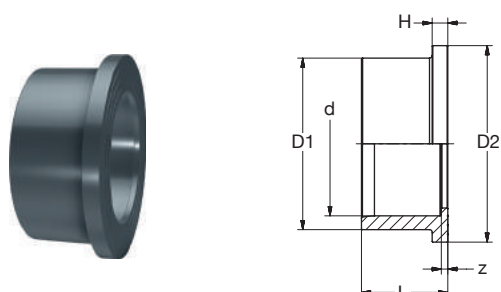

BR PVC-U Bundbuchse gerillt grau
BR PVC-U Flange adaptor socket grooved grey

Art Nr	d	DN	D1	D2	H	L	z	PN	KG	VE1	VE2
Art No	[mm]		[mm]	[mm]	[mm]	[mm]	[mm]	[bar]		PU1	PU2
1330 06F0 12	20	15	27	34	6	19	3	16	0,010	10	200
1330 07F0 12	25	20	33	41	7	22	3	16	0,015	10	100
1330 08F0 12	32	25	41	50	7	25	3	16	0,023	10	100
1330 09F0 12	40	32	50	61	8	29	3	16	0,039	10	100
1330 10F0 12	50	40	61	74	10	35	4	16	0,065	10	60
1330 11F0 12	63	50	76	90	10	41	3	16	0,10	2	20
1330 12F0 12	75	65	90	106	10	47	3	16	0,16	2	14
1330 13F0 12	90	80	108	125	11	56	5	16	0,26	2	18
1330 14F0 12	110	100	131	150	12	66	5	16	0,42	2	8
1330 16F0 12	140	125	165	188	14	81	5	16	0,77	2	6
1330 17F0 12	160	150	188	213	16	91	5	16	1,10	2	8
1330 20F0 12	225	200	248	274	25	125	6	10	1,70	1	6
1330 21F0 32	250	225	274	303	23	131	7	10	2,18	1	-
1330 22F0 32	280	250	306	328	26	146	9	10	2,83	1	-
1330 23F0 32	315	300	342	378	31	164	10	10	4,08	1	-

BR PVC-U Bundbuchse O-Ring grau
BR PVC-U Flange adaptor socket O-Ring grey

Art Nr	d	DN	D1	D2	H	L	z	PN	KG	VE1	VE2
Art No	[mm]		[mm]	[mm]	[mm]	[mm]	[mm]	[bar]		PU1	PU2
1330 05R0 12	16	10	22	29	9	20	6	16	0,006	10	250
1330 06R0 12	20	15	27	34	9	22	6	16	0,011	10	200
1330 07R0 12	25	20	33	41	10	25	6	16	0,017	10	100
1330 08R0 12	32	25	41	50	10	28	6	16	0,026	10	100
1330 09R0 12	40	32	50	61	13	34	8	16	0,044	10	100
1330 10R0 12	50	40	61	73	13	39	8	16	0,070	10	60
1330 11R0 12	63	50	76	90	14	46	8	16	0,12	2	20
1330 12R0 12	75	65	90	106	15	52	8	16	0,19	2	12
1330 13R0 12	90	80	108	125	16	61	10	16	0,30	2	18
1330 14R0 12	110	100	131	150	18	72	11	16	0,46	2	8
1330 16R0 12	140	125	165	188	20	87	11	16	0,84	2	6
1330 17R0 12	160	150	188	213	22	97	11	16	1,21	2	8
1330 20R0 12	225	200	248	274	31	131	12	10	1,88	1	6

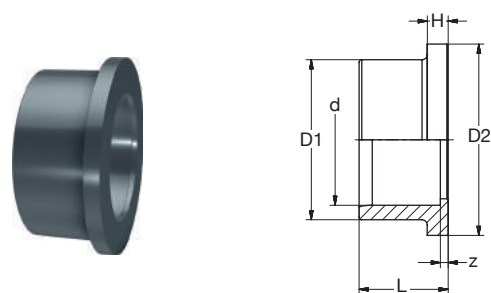

BR PVC-U Bundbuchse glatt grau
BR PVC-U Flange adaptor socket plain grey

Art Nr	d	DN	D1	D2	H	L	z	PN	KG	VE1	VE2
Art No	[mm]		[mm]	[mm]	[mm]	[mm]	[mm]	[bar]		PU1	PU2
1330 0500 12	16	10	22	29	6	17	3	16	0,006	10	250
1330 0600 12	20	15	27	34	6	19	3	16	0,009	10	200
1330 0700 12	25	20	33	41	7	22	3	16	0,014	10	100
1330 0800 12	32	25	41	50	7	25	3	16	0,023	10	100
1330 0900 12	40	32	50	61	8	29	3	16	0,040	10	100
1330 1000 12	50	40	61	74	10	35	4	16	0,062	10	60
1330 1100 12	63	50	76	90	10	41	3	16	0,10	2	20
1330 1200 12	75	65	90	106	10	47	3	16	0,16	2	14
1330 1300 12	90	80	108	125	11	56	5	16	0,26	2	18
1330 1400 12	110	100	131	150	12	66	5	16	0,42	2	8
1330 1600 12	140	125	165	188	14	81	5	16	0,78	2	6
1330 1700 12	160	150	188	213	16	91	5	16	1,14	2	8
1330 2000 12	225	200	248	274	25	125	6	10	1,74	1	6

Zubehör Flanschverbindung B-Buchse PVC-U
Accessories Flange Connection socket PVC-U



Losflansch
Flange loose

d [mm]	DN [mm]	PVC-U		PP-St		ANSI 150 lbs
		DIN/EN				
		PN10/16	PN10	PN10/16	PN10	
16	10	9131 05E1 32				
20	15	9131 06E1 32		14 014 0020 11		14 013 0020 11
25	20	9131 07E1 32		14 014 0025 11		14 013 0025 11
32	25	9131 08E1 12		14 014 0032 11		14 013 0032 11
40	32	9131 09E1 12		14 014 0040 11		14 013 0040 11
50	40	9131 10E1 12		14 014 0050 11		14 013 0050 11
63	50	9131 11E1 12		14 014 0063 11		
75	65	9131 12E1 12		14 014 0075 11		14 013 0075 11
90	80	9131 13E1 12		14 014 0090 11		
110	100	9131 14E1 12		14 014 0110 11		
140	125	9131 16E1 12		14 014 0140 11		
160	150	9131 17E1 12		14 014 0160 11		
225	200		9132 20E2 32		14 015 0225 11	
250	225		9132 21E2 32			
280	250		9132 22E2 32			
315	300		9132 23E2 32			



Blindflansch
Flange blind

DN [mm]	PP-St		ANSI 150 lbs
	DIN/EN		
	PN10/16	PN10	
16	14 045 0020 11		11 043 0020 11
20	14 045 0025 11		11 043 0025 11
25	14 045 0032 11		11 043 0032 11
32	14 045 0040 11		11 043 0040 11
40	14 045 0050 11		11 043 0050 11
50	14 045 0063 11		11 043 0063 11
63	14 045 0075 11		11 043 0075 11
75	14 045 0090 11		11 043 0090 11
90	14 045 0110 11		11 043 0110 11
110	14 045 0140 11		
140	14 045 0160 11		11 043 0160 11
160		14 045 0225 11	11 043 0200 11
225		14 045 0250 11	11 043 0250 11
250		14 045 0280 11	
280		14 045 0300 11	11 043 0315 11

Flachdichtringe für BB gerillt und flach
Flat-Gasket for flange adaptor grooved and plain



mit Stahl-Einlage
with Steel-inlay

Runddichtringe für BB mit O-Ring-Kammer
O-Ring-Gasket for flange adaptor with O-Ring



d [mm]	DN [mm]	EPDM			EPDM-St		NBR-St		EPDM		FKM (FPM)	
		Wasser/Water		Wasser/Water		Gas/Gas		Wasser/Water		Wasser/Water		
		PN10		PN10		PN10		PN10		PN10		
16	10	9201 05F1 35	9202 05F1 35	9202 05F2 35	9201 05R1 35	9201 05R3 35						
20	15	9201 06F1 35	9202 06F1 35	9202 06F2 35	9201 06R1 35	9201 06R3 35						
25	20	9201 07F1 35	9202 07F1 35	9202 07F2 35	9201 07R1 35	9201 07R3 35						
32	25	9201 08F1 35	9202 08F1 35	9202 08F1 35	9201 08R1 35	9201 08R3 35						
40	32	9201 09F1 35	9202 09F1 35	9202 09F2 35	9201 09R1 35	9201 09R3 35						
50	40	9201 10F1 35	9202 10F1 35	9202 10F2 35	9201 10R1 35	9201 10R3 35						
63	50	9201 11F1 35	9202 11F1 35	9202 11F2 35	9201 11R1 35	9201 11R3 35						
75	65	9201 12F1 35	9202 12F1 35	9202 12F2 35	9201 12R1 35	9201 12R3 35						
90	80	9201 13F1 35	9202 13F1 35	9202 13F2 35	9201 13R1 35	9201 13R3 35						
110	100	9201 14F1 35	9202 14F1 35	9202 14F2 35	9201 14R1 35	9201 14R3 35						
140	125	9201 16F1 35	9202 16F1 35	9202 16F2 35	9201 16R1 35	9201 16R3 35						
160	150	9201 17F1 35	9202 17F1 35	9202 17F2 35	9201 17R1 35	9201 17R3 35						
225	200	9201 20F1 35	9202 20F1 35	9202 20F2 35	9201 20R1 35	9201 20R3 35						
250	225		9202 21F1 35	9202 21F2 35								
280	250		9202 22F1 35	9202 22F2 35								
315	300		9202 23F1 35	9202 23F2 35								

* Nicht für PVC-U Flansche!
* Not for PVC-U flanges!

ASAHI Flanschdichtung Typ 52

Runddichtringe für BB mit O-Ring-Kammer



DN [mm]	EPDM		PTFE	
	Wasser/Water			
	PN10			
15	52.006.01.015		52.005.01.015	
20	52.006.01.020		52.005.01.020	
25	52.006.01.025		52.005.01.025	
32	52.006.01.032		52.005.01.032	
40	52.006.01.040		52.005.01.040	
50	52.006.01.050		52.005.01.050	
65	52.006.01.065		52.005.01.065	
80	52.006.01.080		52.005.01.080	
100	52.006.01.100		52.005.01.100	
125	52.006.01.125		52.005.01.125	
150	52.006.01.150		52.005.01.150	
200	52.006.01.200		52.005.01.200	
250	52.006.01.250		52.005.01.250	
300	52.006.01.300		52.005.01.300	
350	52.006.01.350		52.005.01.350	

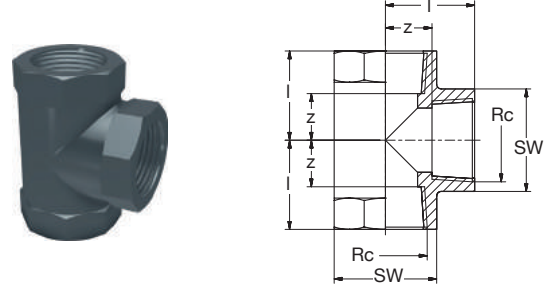
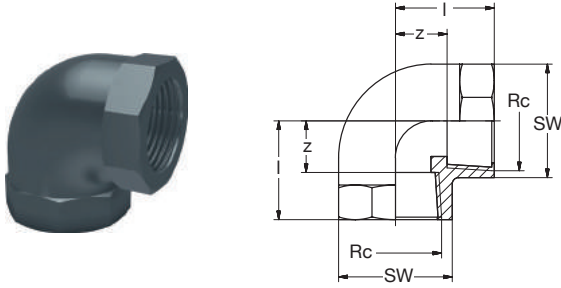

BR PVC-U Winkel 90° IG-keg grau
BR PVC-U Elbow 90° female-thread-con grey

Art Nr	Rc	l	z	SW	PN	KG	VE1	VE2
Art No	[Inch]	[mm]		[bar]		PU1	PU2	
1620 43C0 12	1/2	28	14	30	10	0,030	10	120
1620 45C0 12	3/4	33	17	36	10	0,048	10	80
1620 46C0 12	1	40	22	46	10	0,10	10	80
1620 47C0 12	1 1/4	49	28	55	10	0,15	10	90
1620 48C0 12	1 1/2	59	38	65	1,0	0,27	10	30

BR PVC-U T-Stück 90° IG-keg grau
BR PVC-U Tee 90° female-thread-con grey

Art Nr	Rc	l	z	SW	PN	KG	VE1	VE2
Art No	[Inch]	[mm]		[bar]		PU1	PU2	
1640 43C0 12	1/2	28	14	30	10	0,040	10	80
1640 45C0 12	3/4	33	17	36	10	0,062	10	50
1640 46C0 12	1	40	22	46	10	0,13	10	60
1640 47C0 12	1 1/4	49	28	55	10	0,20	10	30
1640 48C0 12	1 1/2	59	38	65	10	0,35	10	20

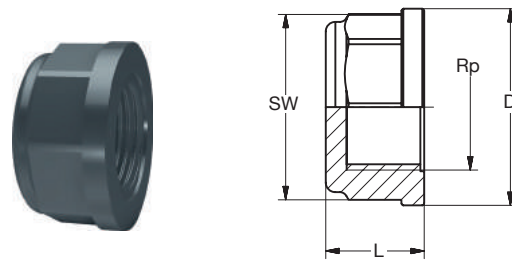
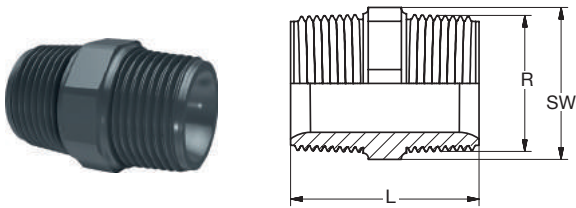

BR PVC-U Doppelnippel AG-keg grau
BR PVC-U Hexagon nipple male-thread-con grey

Art Nr	R	DN	L	SW	PN	KG	VE1	VE2
Art No	[Inch]	[mm]	[mm]	[bar]		PU1	PU2	
1610 7200 12	3/8	10	34	22	10	0,010	10	200
1610 7300 12	1/2	15	43	24	10	0,014	10	200
1610 7500 12	3/4	20	47	30	10	0,022	10	120
1610 7600 12	1	25	53	36	10	0,033	10	80
1610 7700 12	1 1/4	32	57	46	10	0,049	10	120
1610 7800 12	1 1/2	40	57	55	10	0,067	10	60
1610 8000 12	2	50	68	65	10	0,11	10	90

BR PVC-U Kappe IG-zyl grau
BR PVC-U Cap female-thread-cyl grey

Art Nr	Rp	D	L	SW	PN	KG	VE1	VE2
Art No	[Inch]	[mm]	[mm]	[bar]		PU1	PU2	
1690 4000 12	1/8	20	14	17	10	0,004	10	1000
1690 4100 12	1/4	26	16	22	10	0,007	10	400
1690 4200 12	3/8	31	19	27	10	0,011	10	200
1690 4300 12	1/2	37	21	32	10	0,018	10	200
1690 4500 12	3/4	43	24	36	10	0,023	10	160
1690 4600 12	1	52	26	46	10	0,039	10	100
1690 4700 12	1 1/4	62	29	55	10	0,055	10	110
1690 4800 12	1 1/2	66	31	60	10	0,069	10	100
1690 5000 12	2	82	36	75	10	0,12	5	75

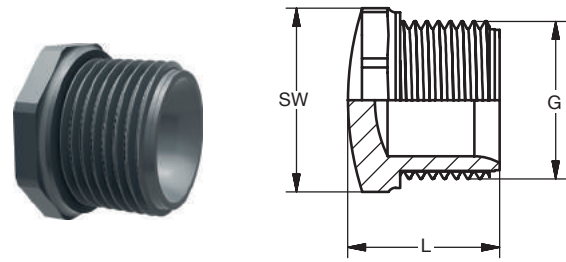
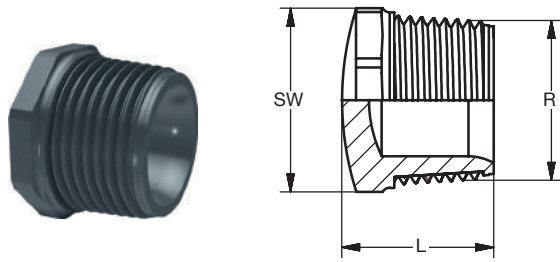

BR PVC-U Stopfen AG-keg grau
BR PVC-U Plug male-thread-con grey

BR PVC-U Stopfen AG-zyl grau
BR PVC-U Plug male-thread-cyl grey

Art Nr	R	L	SW	PN	KG	VE1	VE2
Art No	[Inch]	[mm]	[mm]	[bar]		PU1	PU2
1670 7200 12	3/8	21	22	10	0,010	10	200
1670 7300 12	1/2	27	24	10	0,011	10	150
1670 7500 12	3/4	29	30	10	0,016	10	150
1670 7600 12	1	32	36	10	0,027	10	120
1670 7700 12	1 1/4	36	46	10	0,041	10	80
1670 7800 12	1 1/2	37	55	10	0,062	10	100
1670 8000 12	2	42	65	10	0,096	5	60

Art Nr	G	L	SW	PN	KG	VE1	VE2
Art No	[Inch]	[mm]	[mm]	[bar]		PU1	PU2
1670 72G0 32	3/8	21	22	10	0,010	10	200
1670 73G0 12	1/2	27	24	10	0,016	10	150
1670 75G0 32	3/4	29	30	10	0,010	10	150
1670 76G0 32	1	32	36	10	0,020	10	120
1670 77G0 32	1 1/4	36	46	10	0,050	10	80
1670 78G0 32	1 1/2	37	55	10	0,060	10	100
1670 80G0 32	2	42	65	10	0,10	5	60
1670 83G0 32	2 1/2	59	80	10	0,18	1	-
1670 85G0 32	3	76	93	10	0,26	1	-
1670 87G0 12	4	84	131	10	0,64	1	-

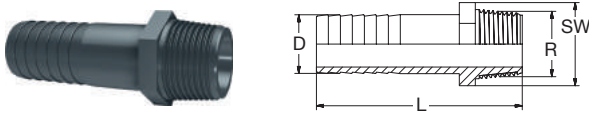

BR PVC-U Druckschlauchtülle AG-keg grau
BR PVC-U Hose nozzle male-thread-con grey

Art Nr	R	DN	D	L	SW	PN	KG	VE1	VE2
Art No	[Inch]		[mm]	[mm]	[mm]	[bar]		PU1	PU2
1680 7100 32	1/4	8	12	51	14	10	0,010	10	-
1680 7200 32	3/8	10	16	57	19	10	0,010	10	-
1680 7300 32	1/2	15	20	73	22	10	0,020	10	-
1680 7500 32	3/4	20	25	79	27	10	0,030	10	-
1680 7600 32	1	25	30	89	36	10	0,040	10	-
1680 7700 32	1 1/4	32	40	100	46	10	0,080	10	-
1680 7800 32	1 1/2	40	50	114	52	10	0,11	10	-
1680 8000 32	2	50	60	132	65	10	0,13	10	-

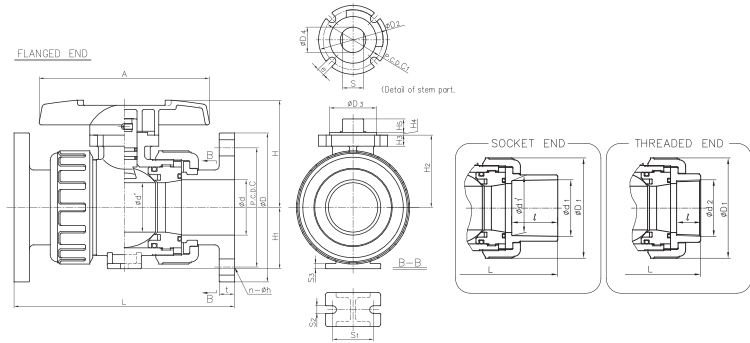

ASAHI PVC-U Kugelhahn Typ 21 Dichtung EPDM/FKM
 ASAHI PVC-U Ball Valve Type 21 gasket EPDM/FKM

DN [mm]	Art Nr	Socket [mm]			Art Nr	Threaded [mm]			Art Nr	Flange [mm]			t	PN [bar]	VE1 PU1		
		d1	l	L		d2	l	L		D	C	n				h	L
		EPDM			EPDM			EPDM									
10	21.106.04.010	16	14	99	21.106.03.010	3/8	15	99	21.106.01.010	90	60	4	14	120	12	16	1
15	21.106.04.015	20	16	102	21.106.03.015	1/2	15	102	21.106.01.015	95	65	4	14	130	12	16	1
20	21.106.04.020	25	19	119	21.106.03.020	3/4	17	120	21.106.01.020	105	75	4	14	150	14	16	1
25	21.106.04.025	32	22	131	21.106.03.025	1	20	131	21.106.01.025	115	85	4	14	160	14	16	1
32	21.106.04.032	40	26	150	21.106.03.032	1 1/4	22	150	21.106.01.032	140	100	4	18	180	16	16	1
40	21.106.04.040	50	31	164	21.106.03.040	1 1/2	25	163	21.106.01.040	150	110	4	18	200	16	16	1
50	21.106.04.050	63	38	197	21.106.03.050	2	28	197	21.106.01.050	165	125	4	18	230	16	16	1
65	21.106.04.065	75	44	233	21.106.03.065	2 1/2	32	215	21.106.01.065	185	145	4	18	288	18	16	1
80	21.106.04.080	90	51	284	21.106.03.080	3	35	265	21.106.01.080	200	160	8	18	311	21	16	1
100	21.106.04.100	110	61	351	21.106.03.100	4	45	340	21.106.01.100	220	180	8	18	352	18	16	1
		FKM (FPM)			FKM (FPM)			FKM (FPM)									
10	21.107.04.010	16	14	99	21.107.03.010	3/8	15	99	21.107.01.010	90	60	4	14	120	12	16	1
15	21.107.04.015	20	16	102	21.107.03.015	1/2	15	102	21.107.01.015	95	65	4	14	130	12	16	1
20	21.107.04.020	25	19	119	21.107.03.020	3/4	17	120	21.107.01.020	105	75	4	14	150	14	16	1
25	21.107.04.025	32	22	131	21.107.03.025	1	20	131	21.107.01.025	115	85	4	14	160	14	16	1
32	21.107.04.032	40	26	150	21.107.03.032	1 1/4	22	150	21.107.01.032	140	100	4	18	180	16	16	1
40	21.107.04.040	50	31	164	21.107.03.040	1 1/2	25	163	21.107.01.040	150	110	4	18	200	16	16	1
50	21.107.04.050	63	38	197	21.107.03.050	2	28	197	21.107.01.050	165	125	4	18	230	16	16	1
65	21.107.04.065	75	44	233	21.107.03.065	2 1/2	32	215	21.107.01.065	185	145	4	18	288	18	16	1
80	21.107.04.080	90	51	284	21.107.03.080	3	35	265	21.107.01.080	200	160	8	18	311	21	16	1
100	21.107.04.100	110	61	351	21.107.03.100	4	45	340	21.107.01.100	220	180	8	18	352	18	16	1

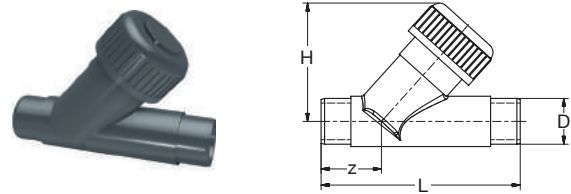
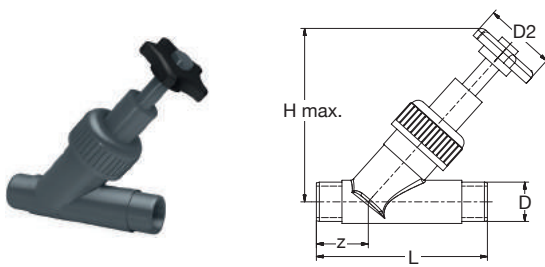

BR PVC-U Ventil Schrägsitz Runddichtring-EPDM grau
BR PVC-U Valve angle seat O-Ring-gasket-EPDM grey

BR PVC-U Ventil Schrägsitz Rückschlag Runddichtring-EPDM grau
BR PVC-U Valve angle seat non-return O-Ring-gasket-EPDM grey

Art Nr	D	DN	D2	L	H	z	PN	KG	VE1	VE2
Art No	[mm]		[mm]	[mm]	[mm]	[mm]	[bar]		PU1	PU2
1930 0500 32	16	10	50	114	105	24	10	0,12	A	-
1930 0600 32	20	15	63	124	135	33	10	0,23	1	-
1930 0700 32	25	20	63	144	135	33	10	0,25	1	-
1930 0800 32	32	25	63	154	143	37	10	0,35	1	-
1930 0900 32	40	32	80	174	182	48	10	0,62	1	-
1930 1000 32	50	40	80	194	204	48	10	1,09	1	-
1930 1100 32	63	50	100	224	276	60	10	1,52	1	-

Art Nr	D	DN	L	H	z	PN	KG	VE1	VE2
Art No	[mm]		[mm]	[mm]	[mm]	[bar]		PU1	PU2
1930 06R0 32	20	15	124	65	33	10	0,19	1	-
1930 07R0 32	25	20	144	75	33	10	0,21	1	-
1930 08R0 32	32	25	154	90	37	10	0,32	1	-
1930 09R0 32	40	32	174	102	48	10	0,51	1	-
1930 10R0 32	50	40	194	123	48	10	0,84	1	-
1930 11R0 32	63	50	224	144	60	10	1,40	1	-

Horizontal und vertikal einsetzbar.
Horizontal and vertical use.

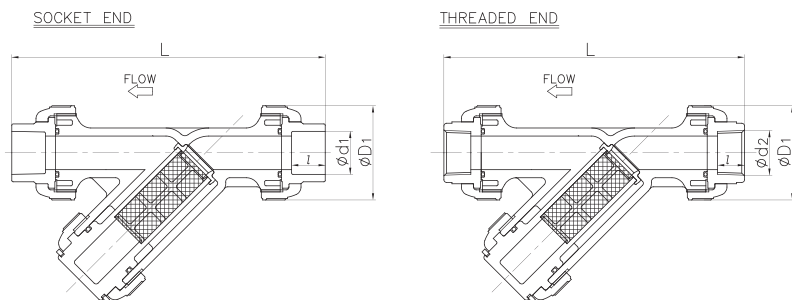

ASAHI Y-Schmutzfänger Typ 51 Dichtung EPDM/FKM
ASAHI Y-Sediment Strainer Type 51 gasket EPDM/FKM

DN [mm]	Art Nr	d1	l	L	Art Nr	D	C	n	h	L	t	PN	KG	VE1	
	Socket [mm]				Flange [mm]				[bar]		PU1				
EPDM															
15	51.106.04.015	20	16	165	51.106.01.015	95	65	4	14	193	12	16	0	1	
20	51.106.04.020	25	19	201	51.106.01.020	105	75	4	14	232	14	16	0	1	
25	51.106.04.025	32	22	224	51.106.01.025	115	85	4	14	253	14	16	0	1	
32	51.106.04.032	40	26	298	51.106.01.032	140	100	4	18	336	16	16	0	1	
40	51.106.04.040	50	31	288	51.106.01.040	150	110	4	18	324	16	16	0	1	
50	51.106.04.050	63	38	337	51.106.01.050	165	125	4	18	360	16	16	0	1	
65	51.106.04.065	75	44	455	51.106.01.065	185	145	4	18	477	18	16	0	1	
80	51.106.04.080	90	51	455	51.106.01.080	200	160	8	18	483	21	16	0	1	
100	51.106.04.100	110	61	607	51.106.01.100	220	180	8	18	608	18	16	0	1	
FKM (FPM)															
15	51.107.04.015	20	16	165	51.107.01.015	95	65	4	14	193	12	16	0	1	
20	51.107.04.020	25	19	201	51.107.01.020	105	75	4	14	232	14	16	0	1	
25	51.107.04.025	32	22	224	51.107.01.025	115	85	4	14	253	14	16	0	1	
32	51.107.04.032	40	26	298	51.107.01.032	140	100	4	18	336	16	16	0	1	
40	51.107.04.040	50	31	288	51.107.01.040	150	110	4	18	324	16	16	0	1	
50	51.107.04.050	63	38	337	51.107.01.050	165	125	4	18	360	16	16	0	1	
65	51.107.04.065	75	44	455	51.107.01.065	185	145	4	18	477	18	16	0	1	
80	51.107.04.080	90	51	455	51.107.01.080	200	160	8	18	483	21	16	0	1	
100	51.107.04.100	110	61	607	51.107.01.100	220	180	8	18	608	18	16	0	1	



ASAHI PVC-U Kugelrückschlagventil Dichtung EPDM/FKM
 ASAHI PVC-U True Union Ball Check gasket EPDM/FKM

DN [mm]	D	Art Nr					Art Nr				Art Nr							PN [bar]	VE1 PU1
		Socket [mm]			Threaded [mm]		Flange [mm]			D	C	n	h	L	t				
		EPDM					EPDM				EPDM								
15	48	31.106.07.015	20	16	81	31.106.03.015	1/2	15	80	31.106.01.015	80	65	4	12	130	12	16	1	
20	60	31.106.07.020	25	19	96	31.106.03.020	1/4	17	95	31.106.01.020	85	65	4	12	155	14	16	1	
25	70	31.106.07.025	32	22	107	31.106.03.025	1	20	105	31.106.01.025	95	75	4	12	165	14	16	1	
32	96	31.106.07.032	50	31	150	31.106.03.032	1 1/2	25	141	31.106.01.032	120	95	4	15	192	16	16	1	
40	96	31.106.07.040	50	31	150	31.106.03.040	1 1/2	25	141	31.106.01.040	120	95	4	15	192	16	16	1	
50	106	31.106.07.050	63	38	181	31.106.03.050	2	28	164	31.106.01.050	130	105	4	15	214	16	16	1	
		FKM (FPM)					FKM (FPM)				FKM (FPM)								
15	48	31.107.07.015	20	16	81	31.107.03.015	1/2	15	80	31.107.01.015	80	65	4	12	130	12	16	1	
20	60	31.107.07.020	25	19	96	31.107.03.020	1/4	17	95	31.107.01.020	85	65	4	12	155	14	16	1	
25	70	31.107.07.025	32	22	107	31.107.03.025	1	20	105	31.107.01.025	95	75	4	12	165	14	16	1	
40	96	31.107.07.032	50	31	150	31.107.03.032	1 1/2	25	141	31.107.01.032	120	95	4	15	192	16	16	1	
40	96	31.107.07.040	50	31	150	31.107.03.040	1 1/2	25	141	31.107.01.040	120	95	4	15	192	16	16	1	
50	106	31.107.07.050	63	38	181	31.107.03.050	2	28	164	31.107.01.050	130	105	4	15	214	16	16	1	

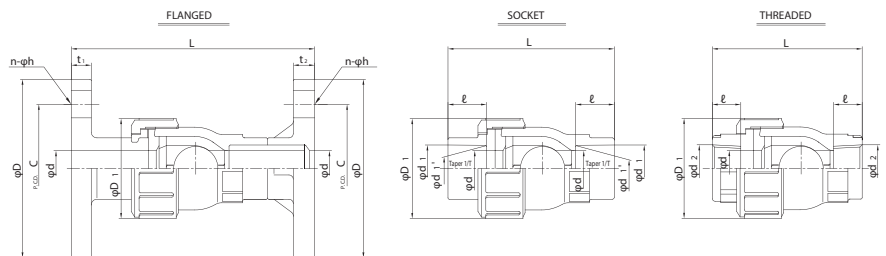

ASAHI PVC-U Kugelrückschlagventil Dichtung EPDM/FKM
 ASAHI PVC-U Single Union Ball Check gasket EPDM/FKM

DN [mm]	D	Art Nr					Art Nr				Art Nr							PN [bar]	VE1 PU1
		Socket [mm]			Threaded [mm]		Flange [mm]			D	C	n	h	L	t				
		EPDM					EPDM				EPDM								
80	152	32.106.08.080	90	51	248	32.106.03.080	3	35	222	32.106.01.080	180	145	4	14	310	18	16	1	
100	210	32.106.08.100	110	61	330	32.106.03.100	4	45	308	32.106.01.100	200	165	8	16	397	18	16	1	
		FKM (FPM)					FKM (FPM)				FKM (FPM)								
80	152	32.107.08.080	90	51	248	32.107.03.080	3	35	222	32.107.01.080	180	145	4	14	310	18	16	1	
100	210	32.107.08.100	110	61	330	32.107.03.100	4	45	308	32.107.01.100	200	165	8	16	397	18	16	1	



FLANGED END

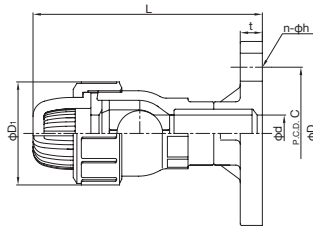

SOCKET END

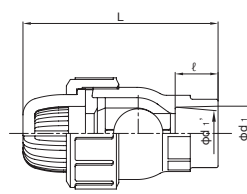

ASAHI Fußventil Typ 30 Dichtung EPDM/FKM
 ASAHI Ball Foot Valve Type 30 gasket EPDM/FKM

Art Nr	d	d1	l	L	Art Nr	D	C	n	h	L	t	PN	VE1		
Art No	[mm]	Socket [mm]			Flange [mm]								[bar]	PU1	
EPDM					EPDM										
30.106.04.015	15	20	16	91	30.106.01.015	80	60	4	15	130	14	16	1		
30.106.04.020	20	25	19	105	30.106.01.020	85	65	4	15	150	15	16	1		
30.106.04.025	25	32	22	116	30.106.01.025	95	75	4	19	167	15	16	1		
30.106.04.040	40	50	31	178	30.106.01.040	120	95	4	19	246	16	16	1		
30.106.04.050	50	63	38	199	30.106.01.050	130	105	4	19	274	20	16	1		
30.106.04.080	80	90	51	310	30.106.01.080	180	145	8	19	396	22	16	1		
30.106.04.100	100	110	61	390	30.106.01.100	200	165	8	19	506	22	16	1		
FKM (FPM)					FKM (FPM)										
30.107.04.015	15	20	16	91	30.107.01.015	80	60	4	15	130	14	16	1		
30.107.04.020	20	25	19	105	30.107.01.020	85	65	4	15	150	15	16	1		
30.107.04.025	25	32	22	116	30.107.01.025	95	75	4	19	167	15	16	1		
30.107.04.040	40	50	31	178	30.107.01.040	120	95	4	19	246	16	16	1		
30.107.04.050	50	63	38	199	30.107.01.050	130	105	4	19	274	20	16	1		
30.107.04.080	80	90	51	310	30.107.01.080	180	145	8	19	396	22	16	1		
30.107.04.100	100	110	61	390	30.107.01.100	200	165	8	19	506	22	16	1		

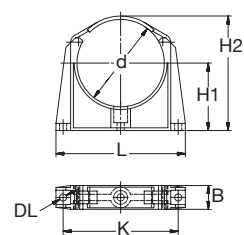
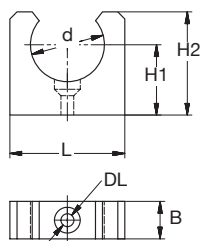

BR PE-Rohrclip schwarz

BR PE-Pipe clip black

Art Nr	d	L	B	H1	H2	DL	nL	KG	VE1	VE2	
Art No	[mm]	[mm]								PU1	PU2
9301 0500 35	16	32	16	24	32	5	1	0,006	10	-	
9301 0600 15	20	32	16	25	34	5	1	0,008	10	800	
9301 0700 15	25	41	17	26	35	6	1	0,011	10	600	
9301 0800 15	32	49	16	30	44	6	1	0,016	10	400	

BR PE-Rohrclip mit PVC-Bügel schwarz

BR PE-Pipe clip with PVC-bracket black

Art Nr	d	L	B	H1	H2	K	DL	nL	KG	VE1	
Art No	[mm]	[mm]									PU1
9301 090B 35	40	58	25	43	68	-	7	1	0,03	10	
9301 100B 35	50	69	25	47	77	-	7	1	0,03	10	
9301 110B 35	63	84	25	57	93	-	9	1	0,04	10	
9301 120B 35	75	125	30	64	107	109	9	3	0,09	10	
9301 130B 35	90	143	30	73	124	125	9	3	0,11	6	
9301 140B 35	110	163	30	85	146	145	9	3	0,14	6	
9301 150B 35	125	183	39	117	187	165	9	3	0,23	6	
9301 160B 35	140	199	40	132	207	181	9	3	0,28	4	
9301 170B 35	160	220	40	150	235	202	9	3	0,33	4	



Art Nr	Inhalt Content	Beschreibung	Description	KG	VE1
Art No					PU1
799298010	1000ml	TANGIT PVC-U/C Reiniger	TANGIT PVC-U/C Cleaner	0,94	12
AHK-PE-Reiniger	750ml	AHK PE Reiniger	AHK PE Cleaner	0,75	12
AHK-PE-Tuecher	120 Blatt	AHK PE Reinigungstücher	AHK PE Cleaning Sheets	0,5	12
799298117	500ml	DYTEX Reiniger/Anlöser	DYTEX Cleaner / Solver	0,5	6
REINIGUNGSTUCH260	60 Blatt	Reinigungstuch 100% Zellstoff	Dry Paper Towels 100% Cellulose	0,3	1
REINIGUNGSTUCH240	240 Blatt	Reinigungstuch 100% Zellstoff	Dry Paper Towels 100% Cellulose	0,8	1



Art Nr	Inhalt Content [g]	Beschreibung	Description	KG	VE1
Art No					PU1
799298003	1000	TANGIT PVC-U Kleber Dose	TANGIT PVC-U Adhesive	1,0	8
799298002	500	TANGIT PVC-U Kleber Dose	TANGIT PVC-U Adhesive	0,5	12
799298001	250	TANGIT PVC-U Kleber Dose	TANGIT PVC-U Adhesive	0,25	24
799298000	125	TANGIT PVC-U Tube	TANGIT PVC-U Adhesive	0,1	12
799298116	675	DYTEX Spezialkleber, säurefest	DYTEX adhesive acid-proof	0,7	8



Art Nr	Beschreibung	Description	Für Formteile For fittings	KG	VE1
Art No					PU1
69.299.012	1/2 Zoll	1/2 Inches	10 - 12 mm	0,01	10
69.299.100	1 Zoll	1 Inch	16 - 32 mm	0,01	10
69.299.114	1 1/2 Zoll	1 1/2 Inches	40 - 63 mm	0,01	12
69.299.200	2 Zoll	2 Inches	75 - 160 mm	0,02	12



Art Nr	Inhalt Content	Beschreibung	Description	KG	VE1
Art No					PU1
69.296.001	55m	LOCTITE Gewindefaden	LOCTITE Pipe Sealing Cord		
69.296.002	Rolle	Teflonband	Teflon Tape		
PICA3030	1 Stück	Markierungsstift PicaDry	Marker Pen		



Art Nr	Beschreibung	Description	Für Rohre For pipes	KG	VE1
Art No					PU1
222.0002	Rohrschere	Pipe shear	DA 0 - 42		1
222.0003	Rohrschere	Pipe shear	DA 0 - 63		1
222.0005	Rohrschere Pistole	Pipe shear pistole style	DA 0 - 32		1
222.0660	Rohrabschneider	Pipe cutter	DA 6 - 67		1
222.0751	Rohrabschneider	Pipe cutter	DA 6 - 76		1
222.1250	Rohrabschneider	Pipe cutter	DA 50 - 140		1
222.1680	Rohrabschneider	Pipe cutter	DA 6 - 67		1
auf Anfrage	Ersatzmesser	Replacement Knife			1
W-ZK	Abzieh Klinge				1



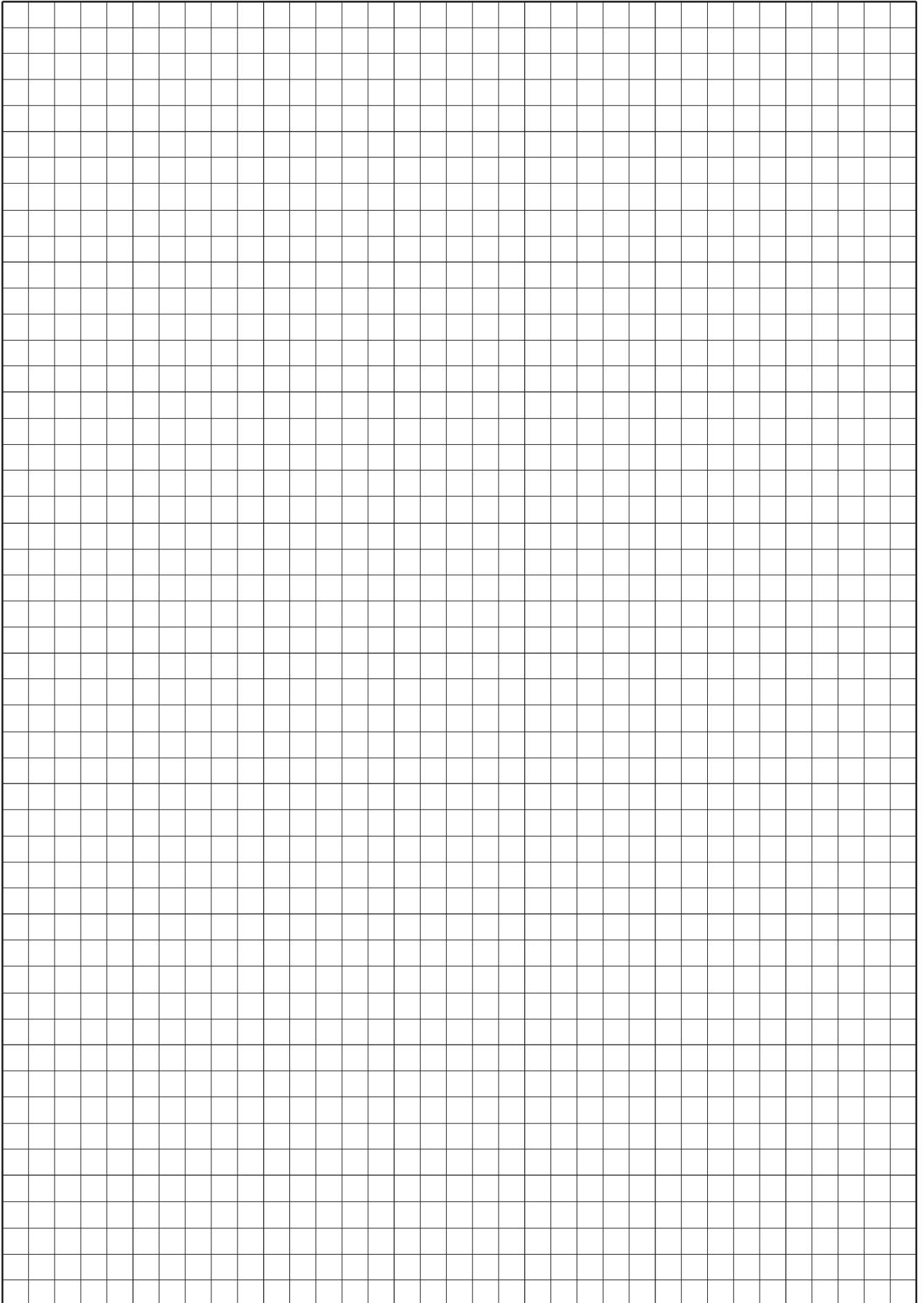

AURO Austria GmbH

Lichtblaustraße 21
AT-1220
Wien

+43 1 256 55 55
at@auro.group

AURO spol. s r.o.

Technická 539/2
CZ-664 48
Moravany u Brna

+420 545 234 753
cz@auro.group

AURO Budapest Kft.

Gyár u. 2.
HU-2040
Budaörs

+36 23 503 920
hu@auro.group

AURO Bulgaria EOOD

Illiciario;3, Azalia Str.
BG-1271
Sofia

+359 2 489 45 19
bg@auro.group

www.auro.group